

MATLAB EXPO

AI Driven Next Generation Wireless Communication Systems

Uvaraj Natarajan, MathWorks



Jayanth Balaji, MathWorks



Agenda

1 Future of Wireless Ecosystem

2 Using AI for wireless

3 AI Workflow for Wireless

4 Reinforcement learning for 5G

5 Summary

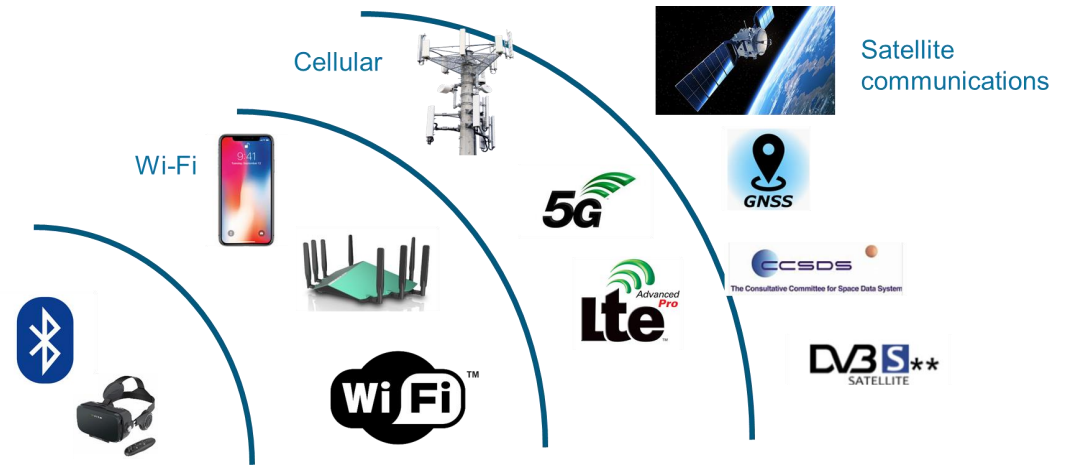

AI-driven system design workflow



Wireless Communications Everywhere

Cross-Industry Applications



Communications Infrastructure
Satellite



Semiconductors and components:
Baseband, RF
Antenna



Mobile Devices

Aero Defence



Connected Devices

- Automotive
- Industrial
- Smart home
- Smart city
- Medical



5G, Satellite and Connectivity (Wi-Fi, BLE, UWB)

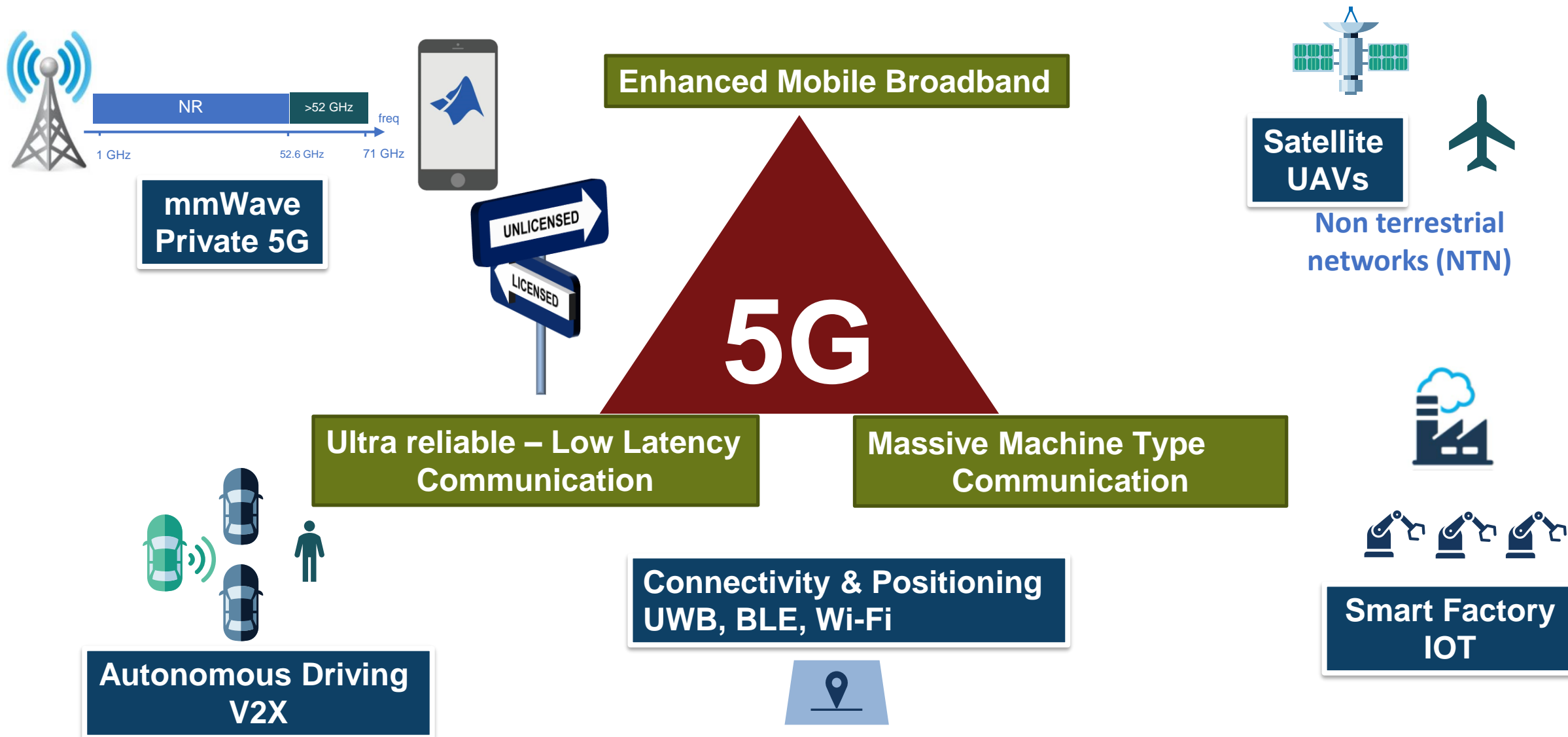

Designing Wireless System: Baseband design

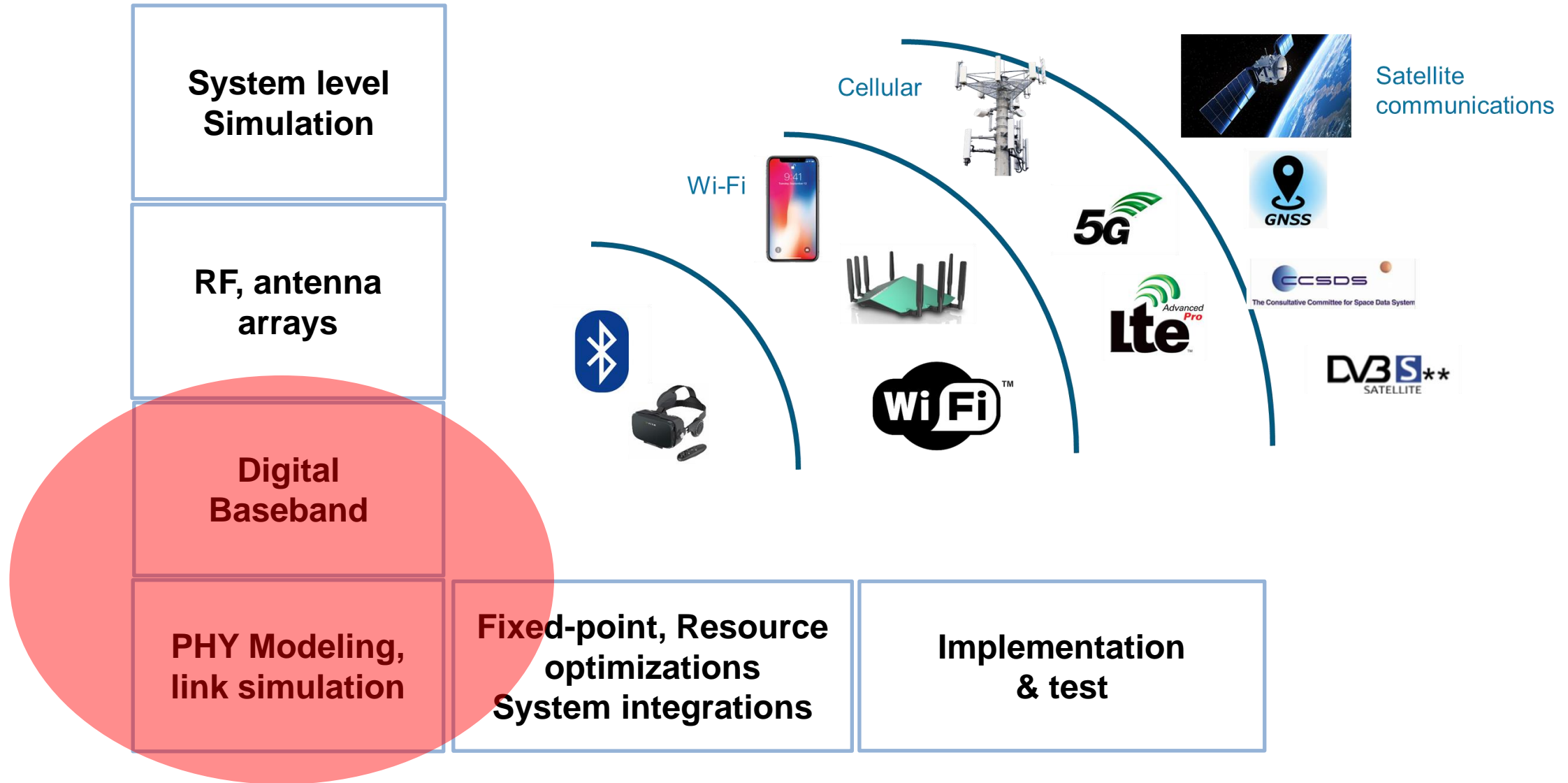

Designing Wireless System: End-to-end Design

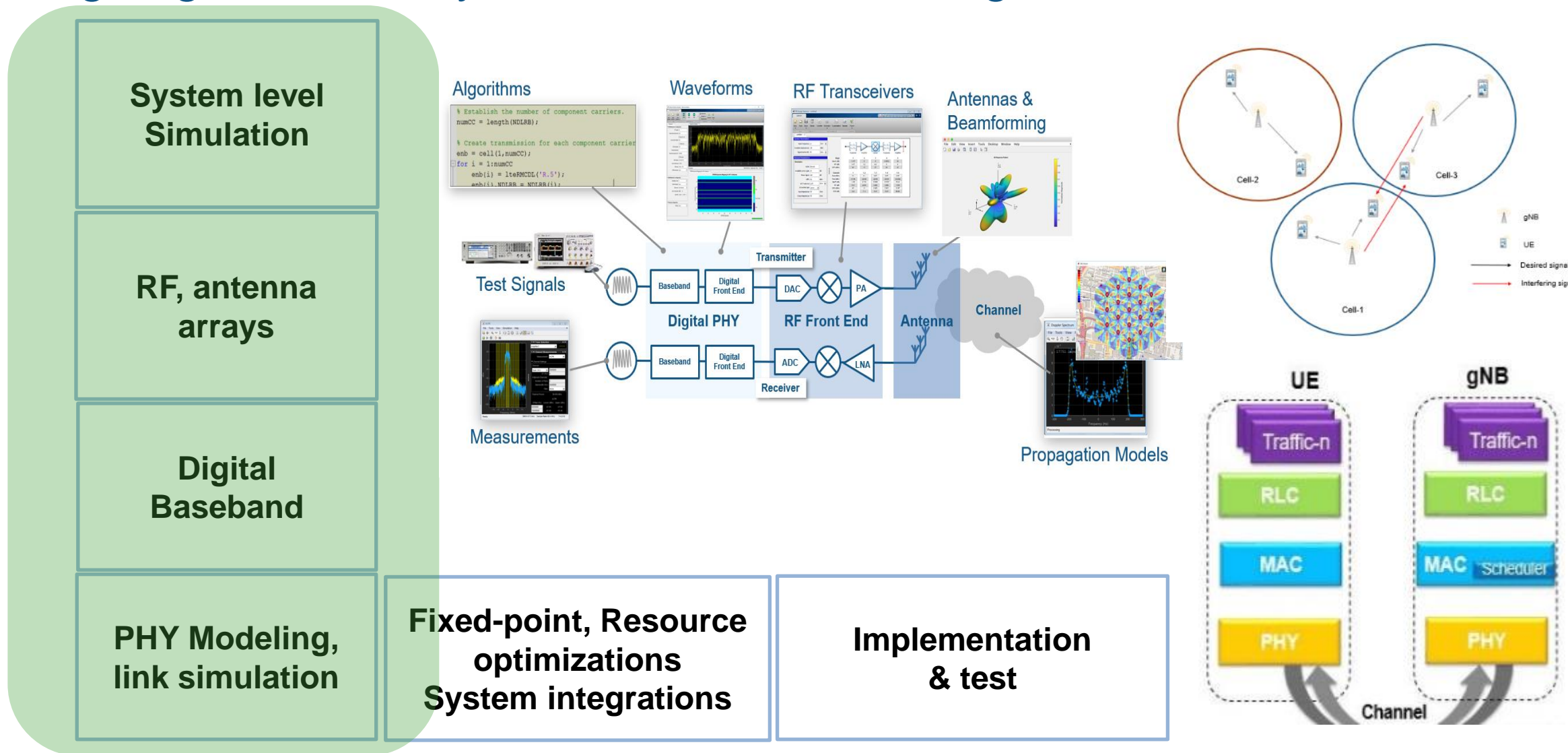

Designing Wireless System: Testing and implementation

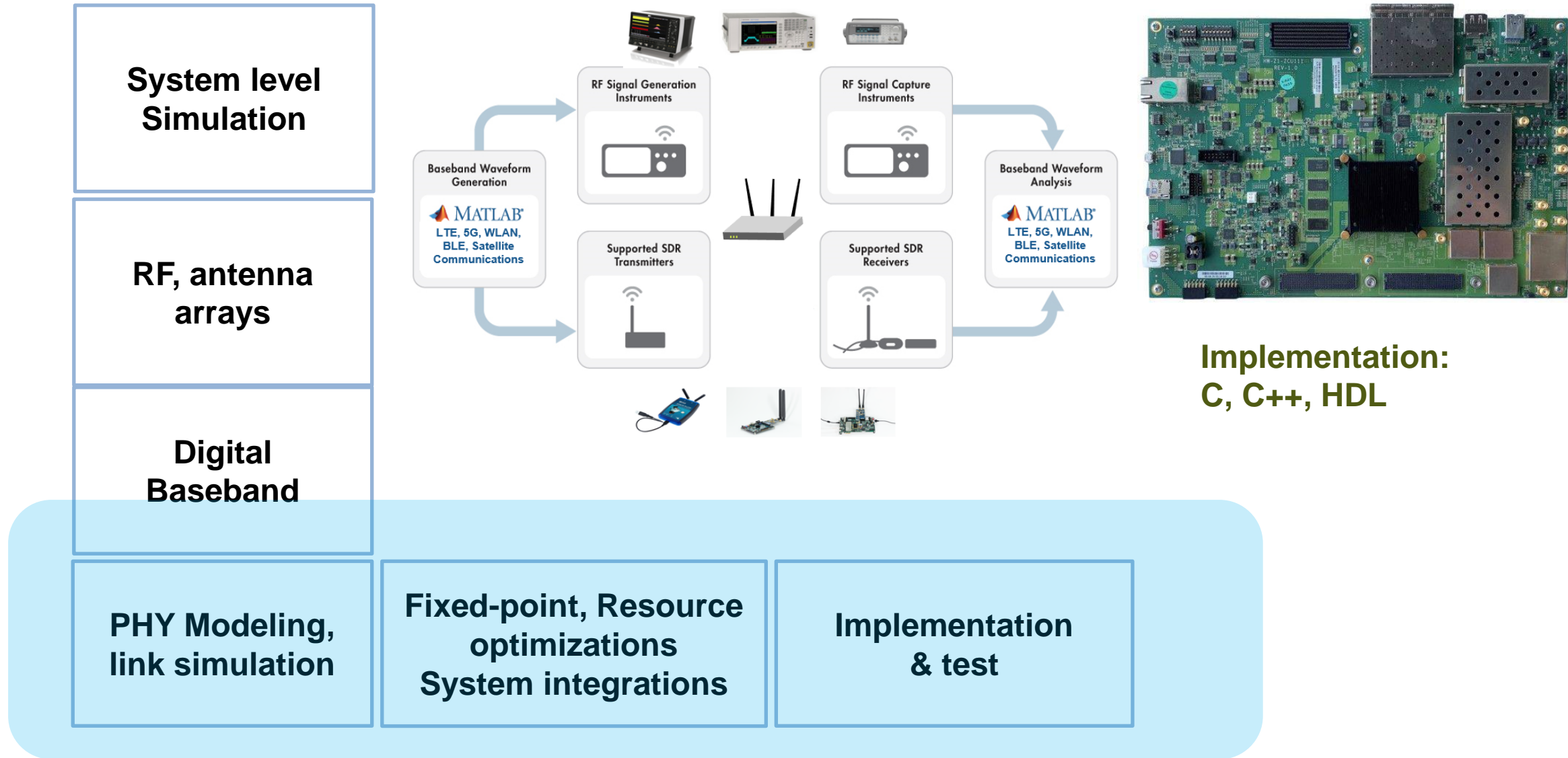

Agenda

1 Future of Wireless Ecosystem

2 Using AI for wireless

3 AI Workflow for Wireless

4 Reinforcement learning for 5G

5 Summary

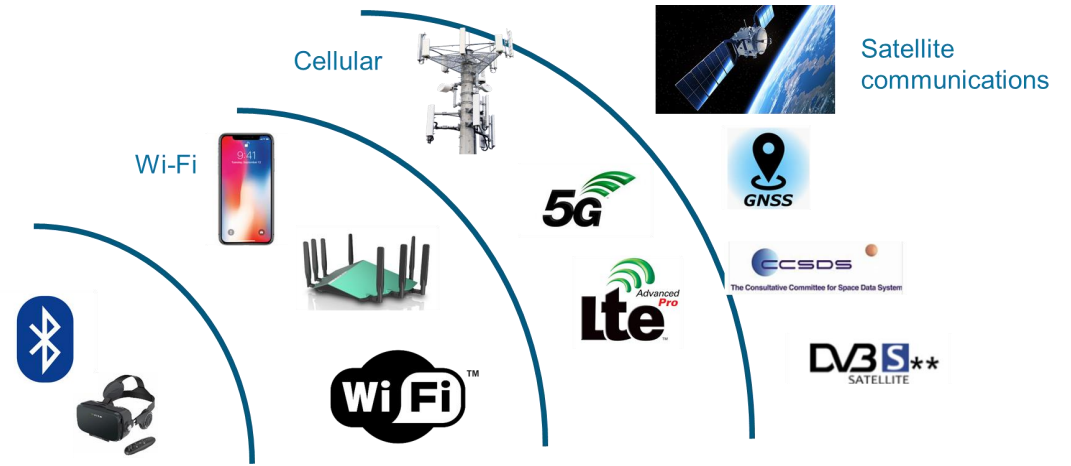

AI-driven system design workflow



Time for AI might be coming: Why now?

- Services expected from the system exceeds the capability of traditional approaches
- Exponential increase in system complexity
- AI shows promising results in other domains



- AI can contribute in multiple ways:
- System architecture flexibility
 - Improved performance
 - Better results



TSG RAN priorities



Release 18

RAN1 led - Radio Layer 1 (Physical layer)

- MIMO Evolution for Downlink and Uplink
- Study on Artificial Intelligence (AI)/Machine Learning (ML) for NR Air Interface
- Study on Evolution of NR Duplex Operation
- NR sidelink evolution
- Study on expanded and improved NR positioning
- Study on further NR RedCap UE complexity/cost reduction
- Study on network energy savings
- Further NR coverage enhancements
- Study on NR Network-Controlled Repeaters
- Enh. of NR Dynamic spectrum sharing (DSS)
- Study on low-power Wake-up Signal and Receiver for NR
- Multi-carrier enhancements for NR

RAN2 led - Radio layer 2 & layer 3 Radio Resource Control

- NR Mobility Enh.
- Study on XR Enh. for NR
- NR sidelink relay enh.
- NR NTN (Non-Terrestrial Networks) enh.
- IoT NTN enh.
- NR Support for UAV
- Dual Tx/Rx MUSIM
- In-Device Co-existence (IDC) enh. for NR and MR-DC
- Mobile Terminated-Small Data Transmission (MT-SDT) for NR
- Enh. of NR Multicast and Broadcast Services

RAN3 led - UTRAN/E-UTRAN/NG-RAN architecture & related network interfaces

- Mobile IAB
- Artificial Intelligence (AI)/Machine Learning (ML) for NG-RAN
- Further enh. of data collection for SON (Self-Organising Networks)/MDT (Minimization of Drive Tests) in NR and EN-DC

RAN4 led - Radio Performance and Protocol Aspects*

- Further RF requirements enh. for NR frequency range 1 (FR1)
- NR RF requirements enh. for frequency range 2 (FR2), Phase 3
- Req. for NR frequency range 2 (FR2) multi-Rx chain DL reception
- RRM enh. for NR and MR-DC
- Enh. on NR and MR-DC Measurement Gaps and Measurements without Gaps
- NR demodulation performance evolution
- Study on simplification of band combination specification
- Study on enh. for 700/800/900MHz band combinations
- NR BS RF requirement evolution
- Study on NR frequency range 2 (FR2) Over-the-Air (OTA) testing enh.
- Support of intra-band non-collocated EN-DC/NR-CA deployment
- Enh. NR support for high speed train scenario in frequency range 2 (FR2)
- BS/UE EMC enh.
- Air-to-ground network for NR
- NR support for dedicated spectrum less than 5MHz for FR1

*There are other approved items related to Rel-17 continuation; more spectrum-related items are expected to be approved later.

TSG CT priorities



Rel-18 Workplan for TSG CT

CT will work on stage 3 completion and ASN.1 code and OpenAPI freeze of Rel-17 until June 2022 (TSG#96).

Work Item discussion on Rel-18 stage 2 / stage 3 (under CT) from June 2022.

CT waits for a stable output of the stage 2 work in SA and RAN before initiating the work on Rel-18 (expected TSG#99 March 2023). Completion of stage 3 is targeted for TSG#103 March 2024.



A look at the research in AI for Wireless Networks

Network-Level Mobile Data Analysis

Network prediction/ Traffic classification

App-Level Mobile Data Analysis

User Mobility Analysis

User Positioning and Localization

SON- Self Optimizing Network

Networks Control

Network optimization/ Routing/ Scheduling/
Resource allocation/ Radio control

Network Security

Signal Processing

Beamforming/ Modulation/
Coding/ Spectrum Sensing/ Channel estimation

Emerging Mobile Network Application

Identify Spectral Content in a Wideband Spectrogram

Spectrum sensing & signal classification:

- Characterizing spectrum occupancy is key to spectrum monitoring
- Neural network can be trained to identify 5G NR and LTE signals in a wideband spectrogram in a specific time for a frequency
- This can be done by applying transfer learning to a semantic segmentation network

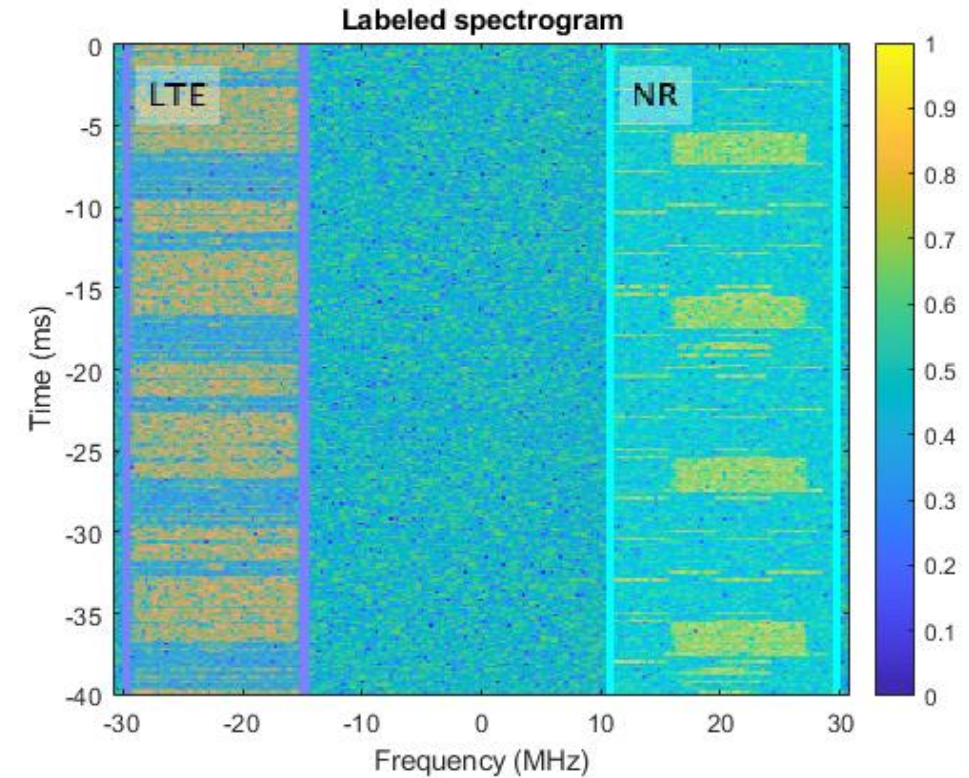
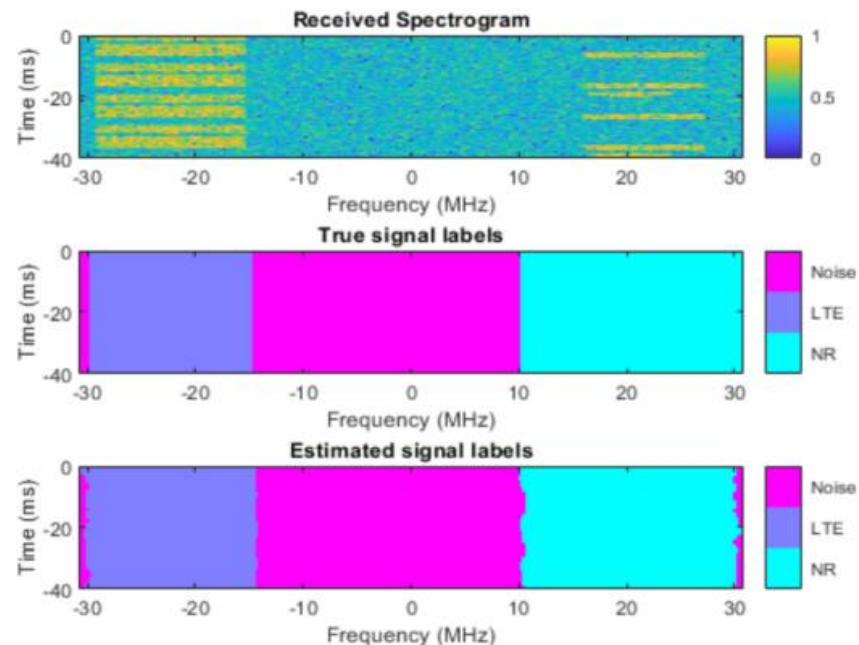

Estimate the 5G Channel

Deep Learning Data Synthesis for 5G Channel Estimation:

- Estimating the accurate channel is a key to 5G System design and performance
- CNN can be trained to various channel conditions and environments with the 5G signal
- This can be an alternate to the traditional channel estimation algorithms

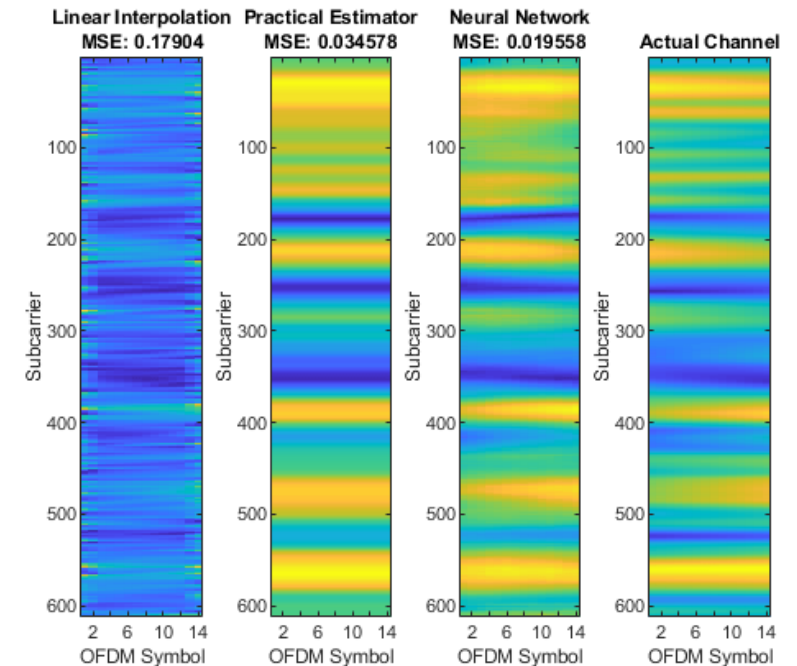
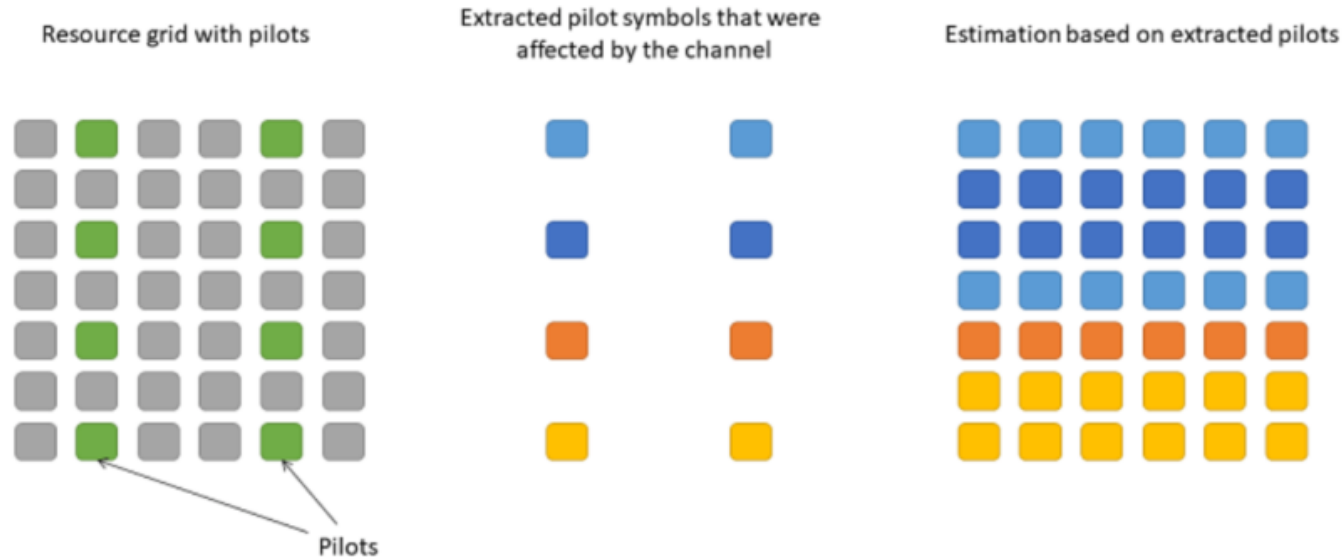

Identify the location of a user

Three-dimensional positioning with WLAN 802.11 az/ 5G NR PRS

- Next generation positioning (NGP) provides physical layer features for ranging and positioning
- This rely on LOS conditions and spatial info for computing position
- CNN can be an alternate for NLOS multipath environment with better accuracy

Office Environment

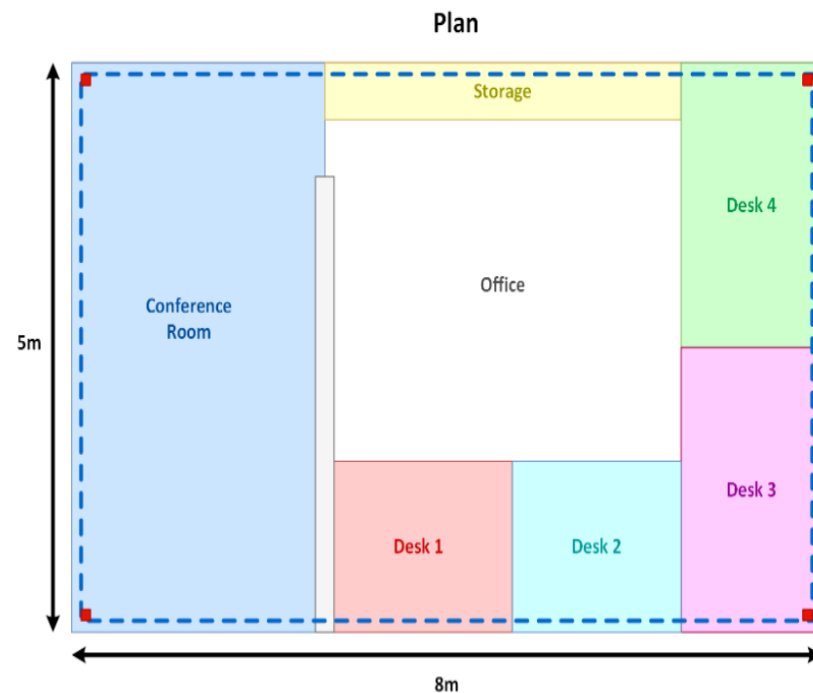

CNN Location Prediction

True STA positions coloured by Predicted Class

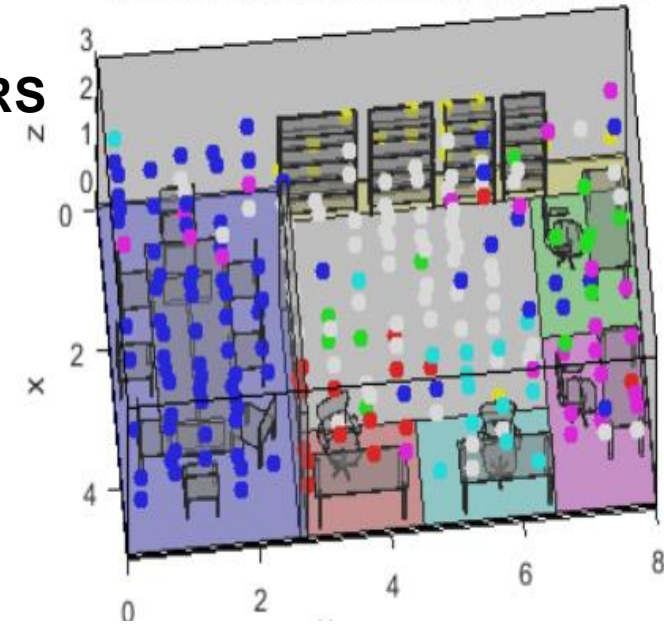

Predicted Class	
●	conference room
●	desk1
●	desk2
●	desk3
●	desk4
○	office
●	storage

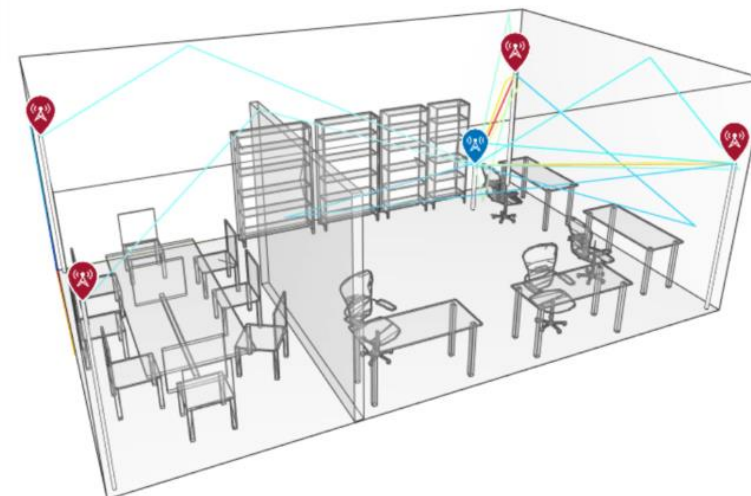
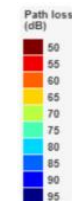

Power Amplifier -Digital Pre-Distortion modeling

Nonlinear behavior of PA results in signal distortion. DPD helps in neutralize the effect

Neural Network based PA-DPD design

- Collect data from a real PA using test instrument hardware or characterize the PA and use the model for simulation
- Train a neural network using real PA data or simulation data
- Test the network with real data using the hardware

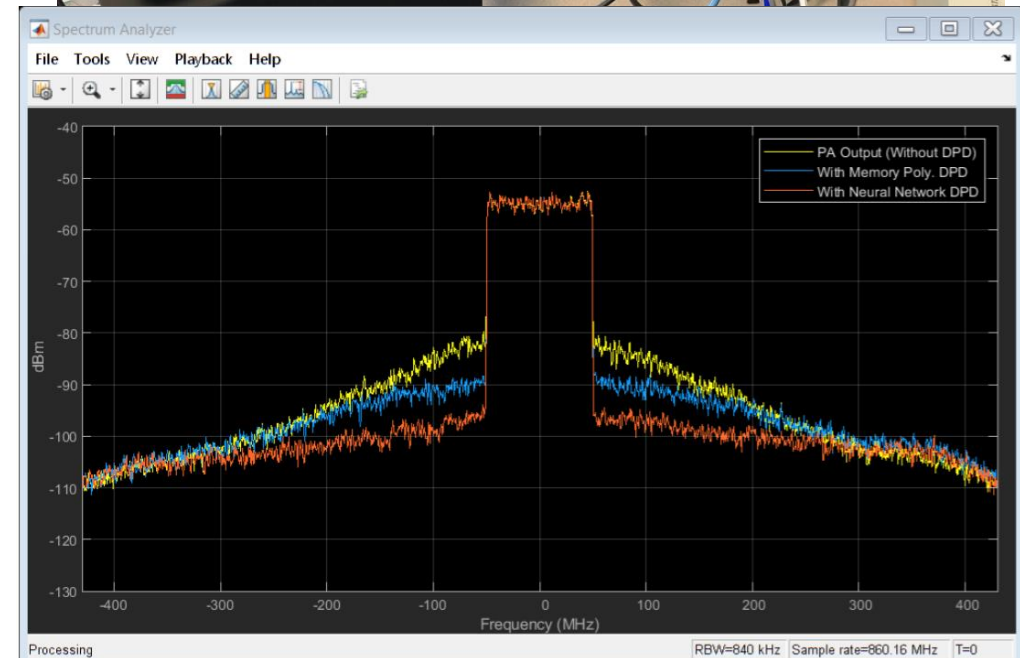
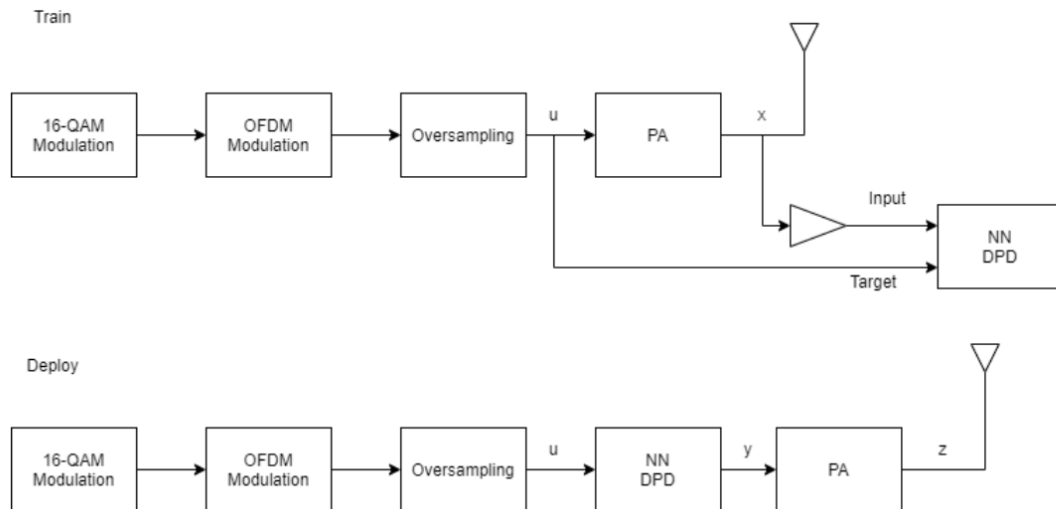
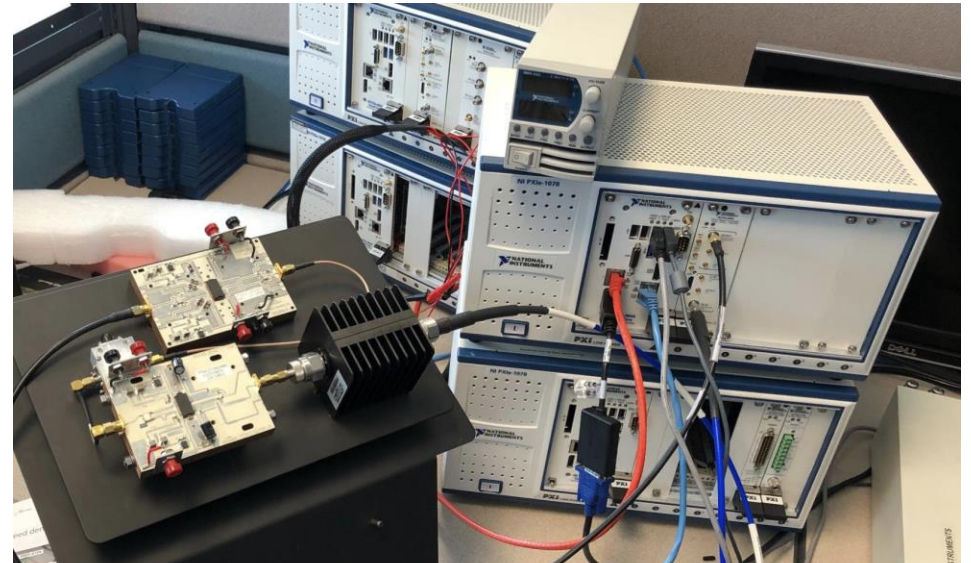

Improve Reliability with Autoencoders

Autoencoder for reliable transmission of information bits over a wireless channel:

- Encoding and decoding is one of the operation in Wireless Communication
- An AI-based autoencoder can jointly optimizes the transmitter and the receiver as a whole
- Autoencoder adds redundancy and tries to minimize the number of errors in the received information for a given channel while learning to apply both channel coding and modulation in an unsupervised way

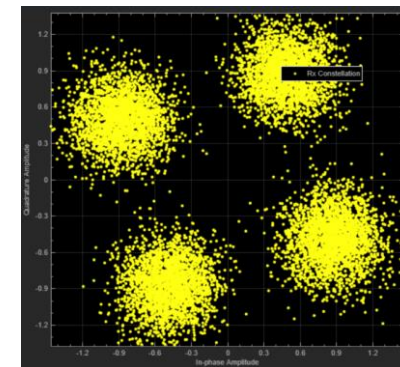
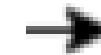
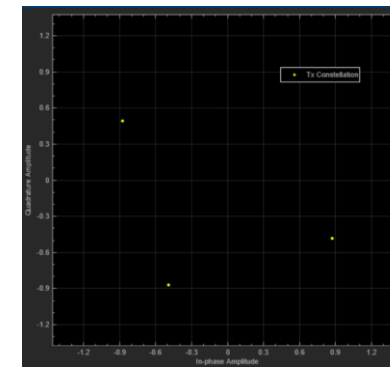
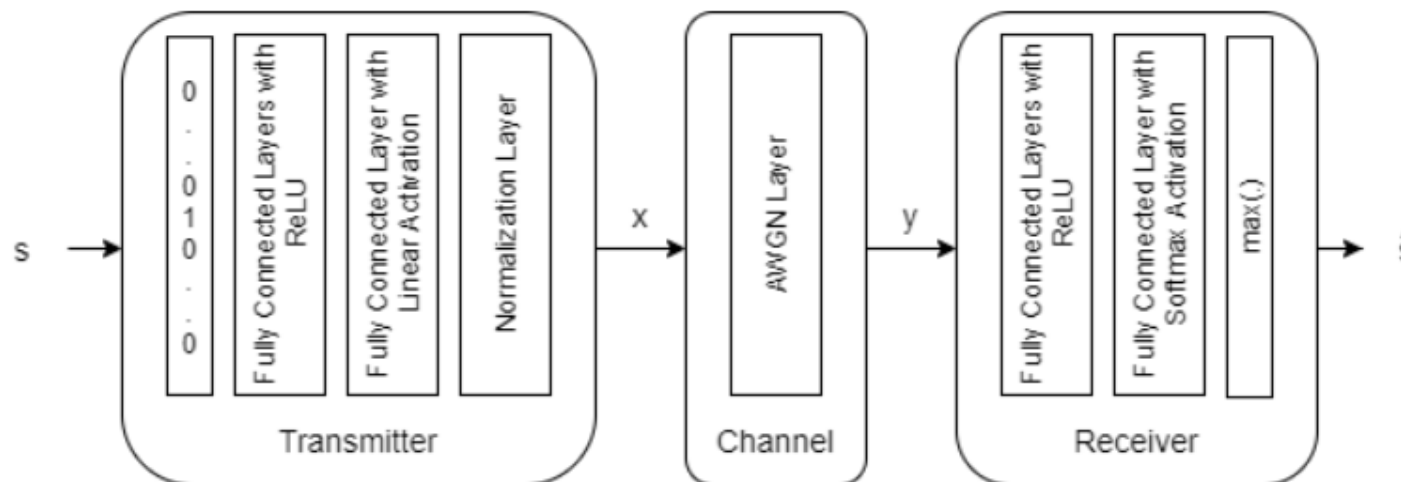
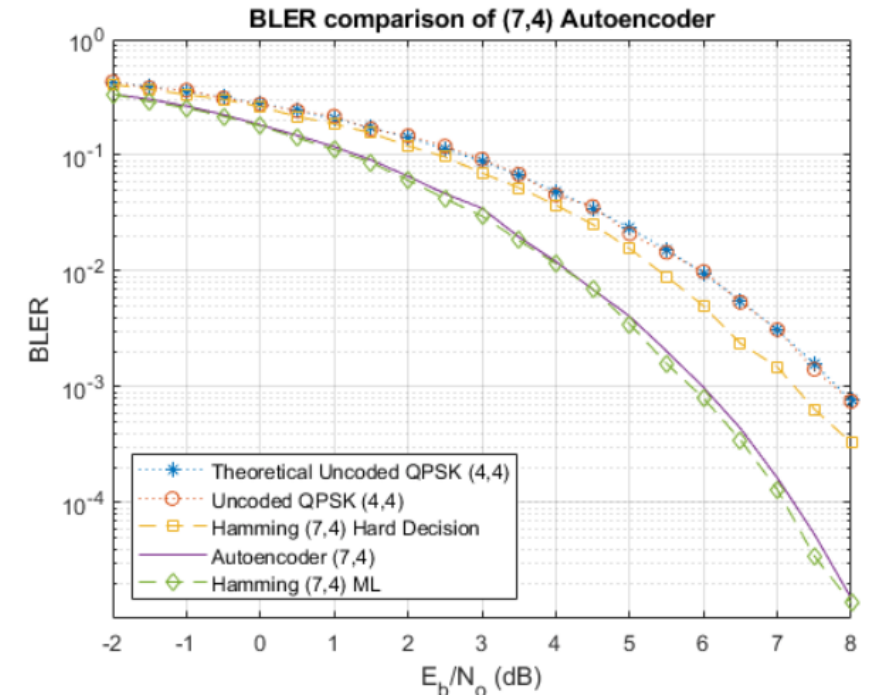

Agenda

1 Future of Wireless Ecosystem

2 Using AI for wireless

3 AI Workflow for Wireless

4 Reinforcement learning for 5G

5 Summary

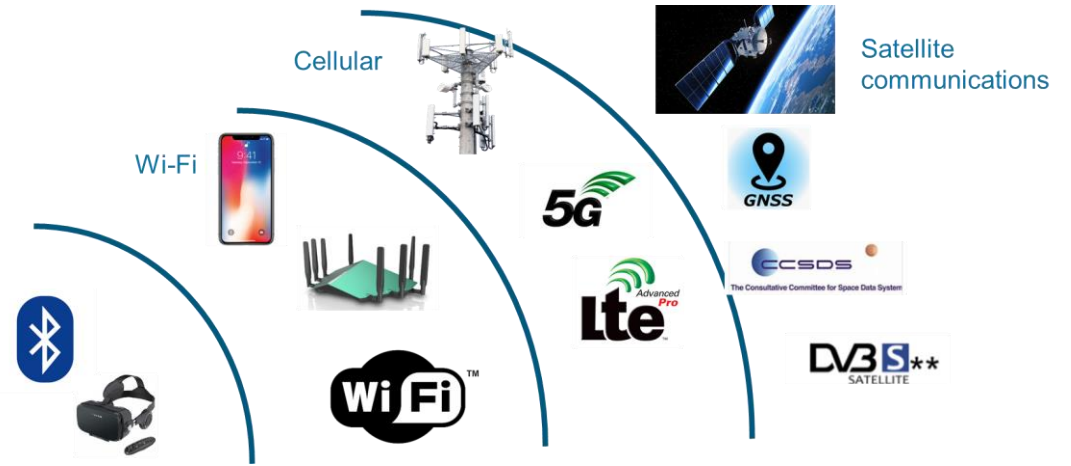

AI-driven system design workflow



AI-Driven Wireless System Design

Data Preparation

- Data cleansing and preparation
- Human insight
- Simulation-generated data

AI Modeling

- Model design and tuning
- Hardware accelerated training
- Interoperability

Simulation & Test

- Integration with complex systems
- System simulation
- System verification and validation

Deployment

- Embedded devices
- Enterprise systems
- Edge, cloud, desktop

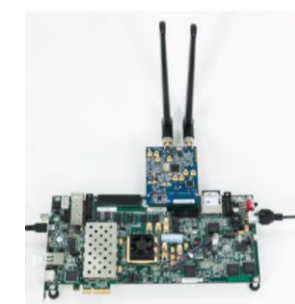
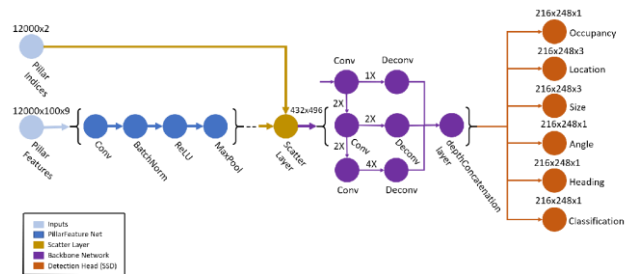
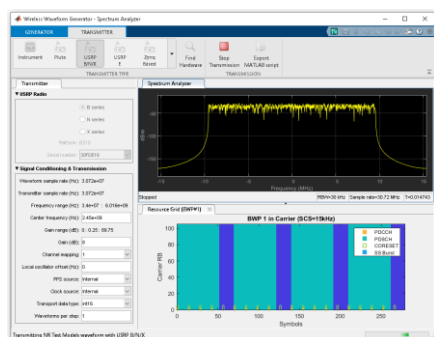

AI-Modeling workflow

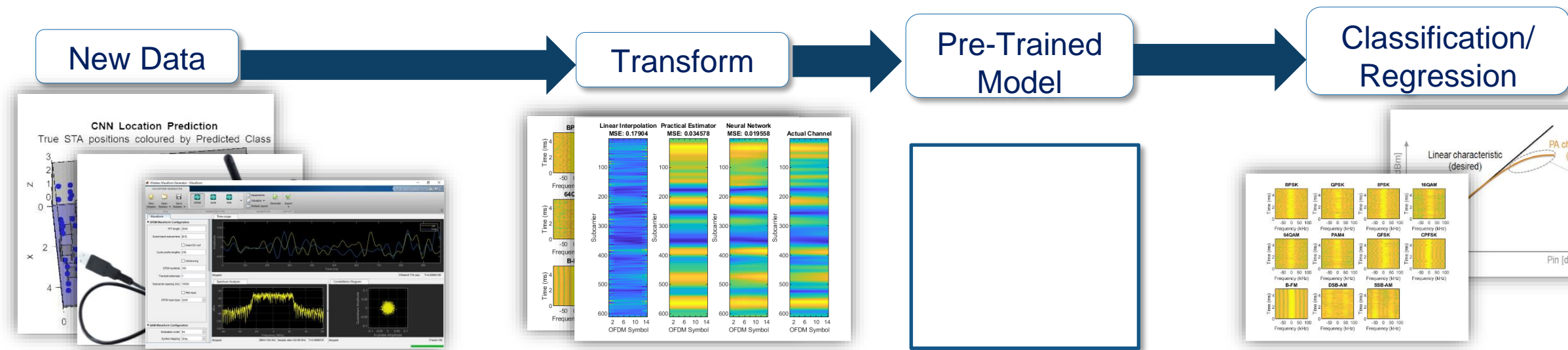

Machine Learning and Deep Learning Taxonomy

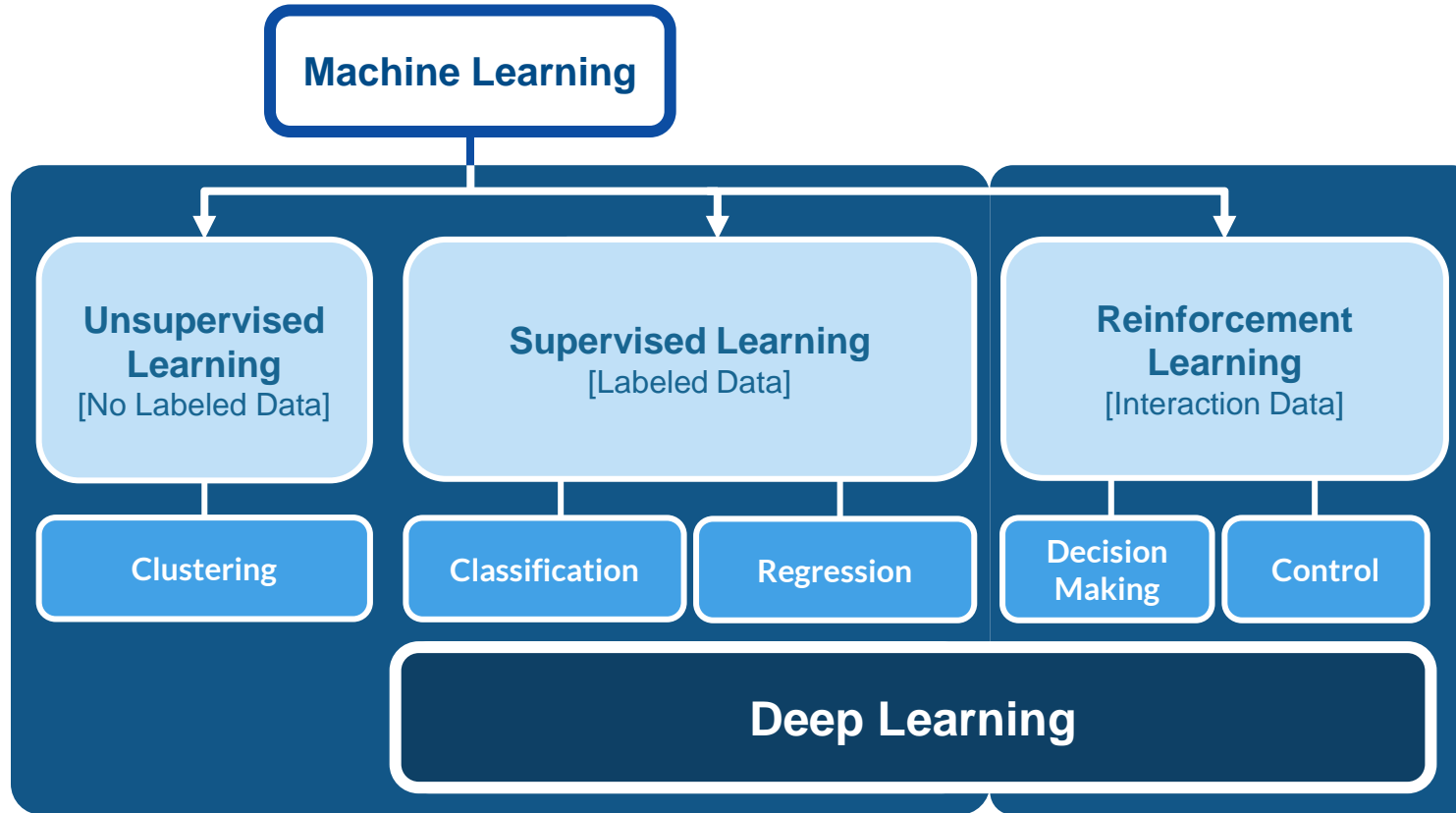

Reinforcement learning:

- Learning through trial & error [*interaction*]
- It's about learning a **behavior** or accomplishing a **task**

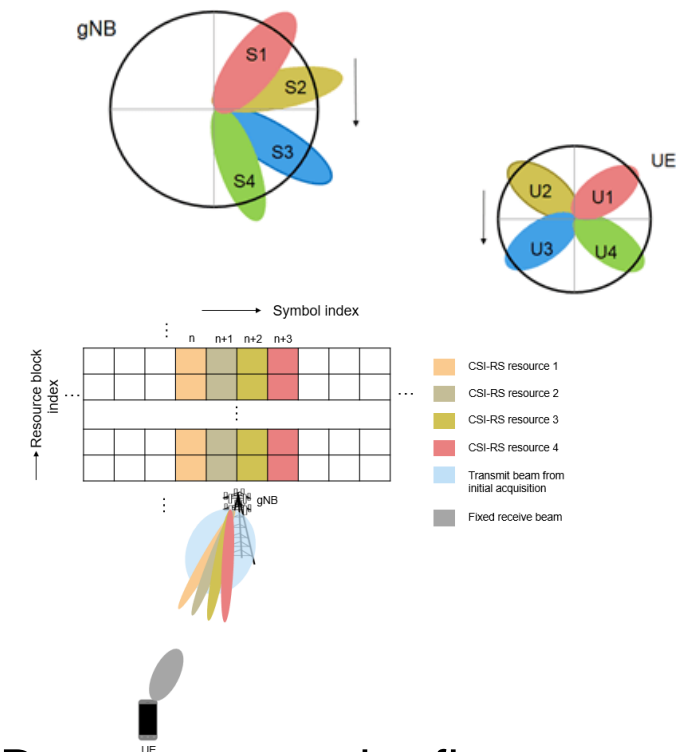

Beam scan and refinement

Agenda

1 Future of Wireless Ecosystem

2 Using AI for wireless

3 AI Workflow for Wireless

4 Reinforcement learning for 5G

5 Summary

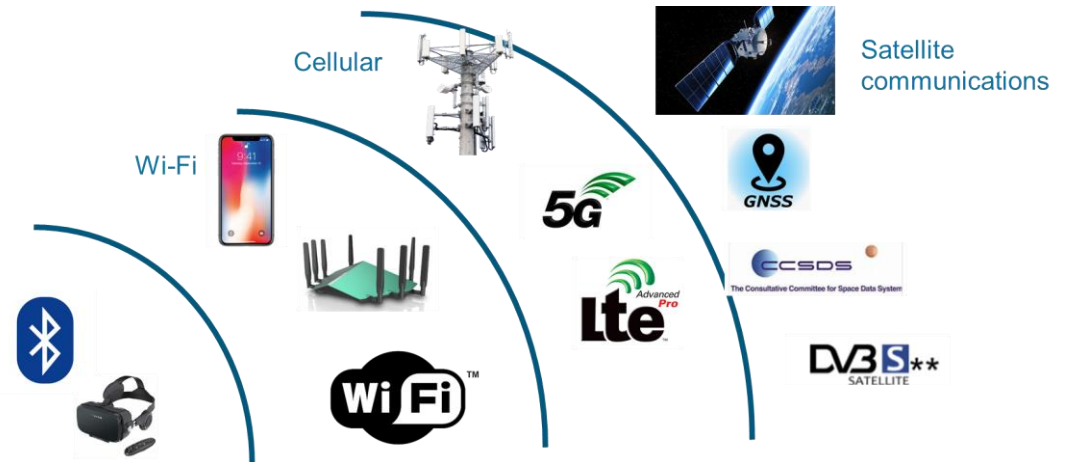

AI-driven system design workflow



Beam management for mmWave Communication

- Beam sweeping
- Beam measurement
- Beam determination
- Beam reporting
- Beam tracking
- Beam recovery

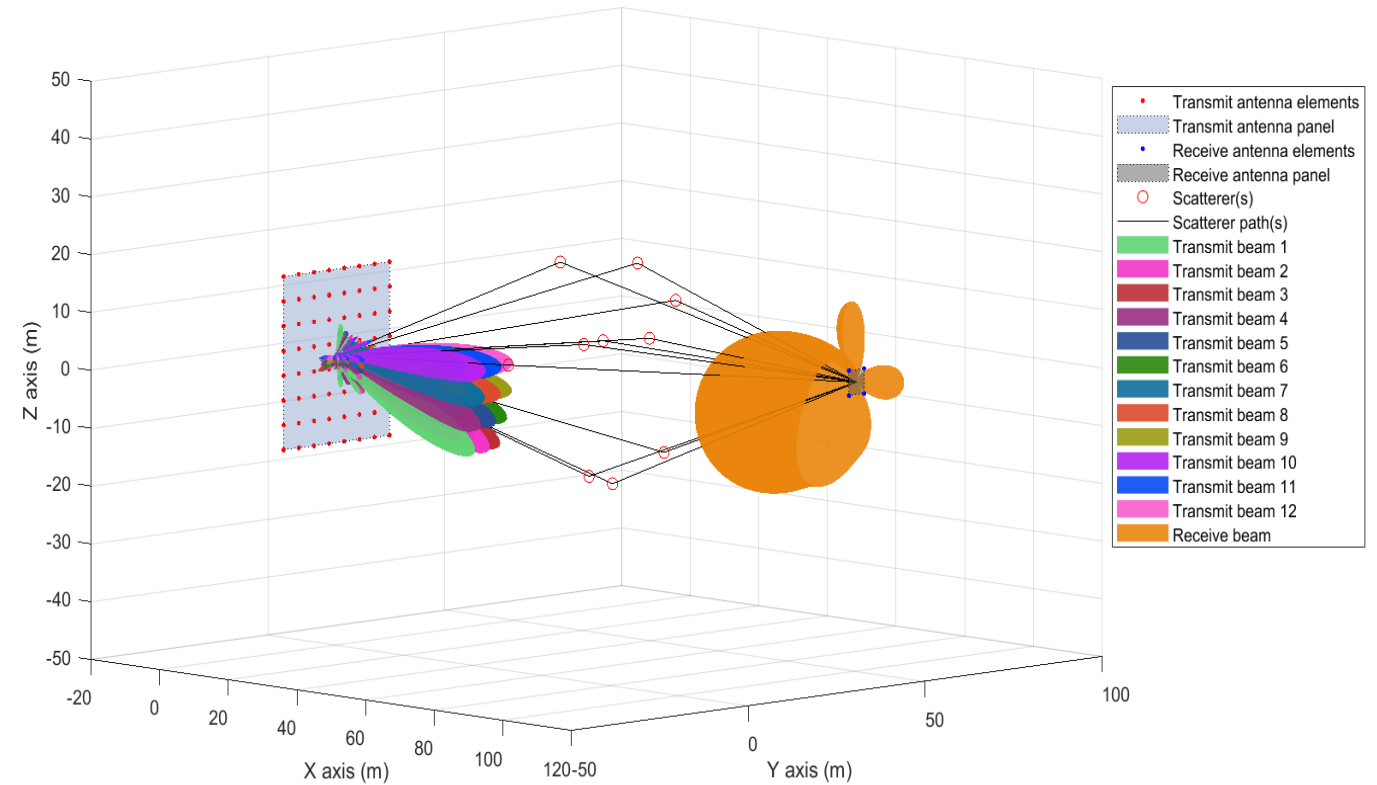
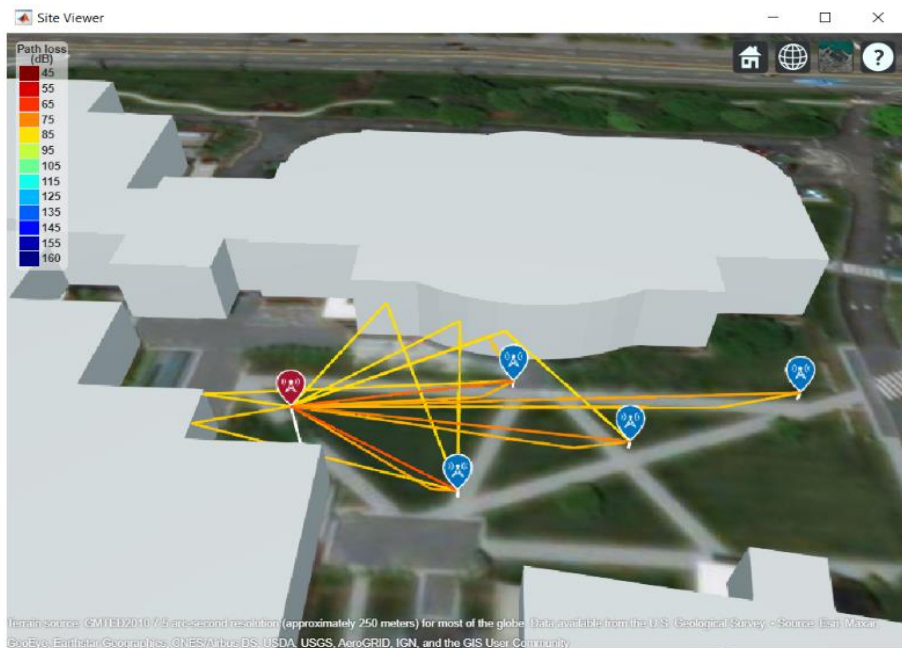

White Paper: [5G NR Beam Management](#)

5G NR SSB Beam Sweeping procedure

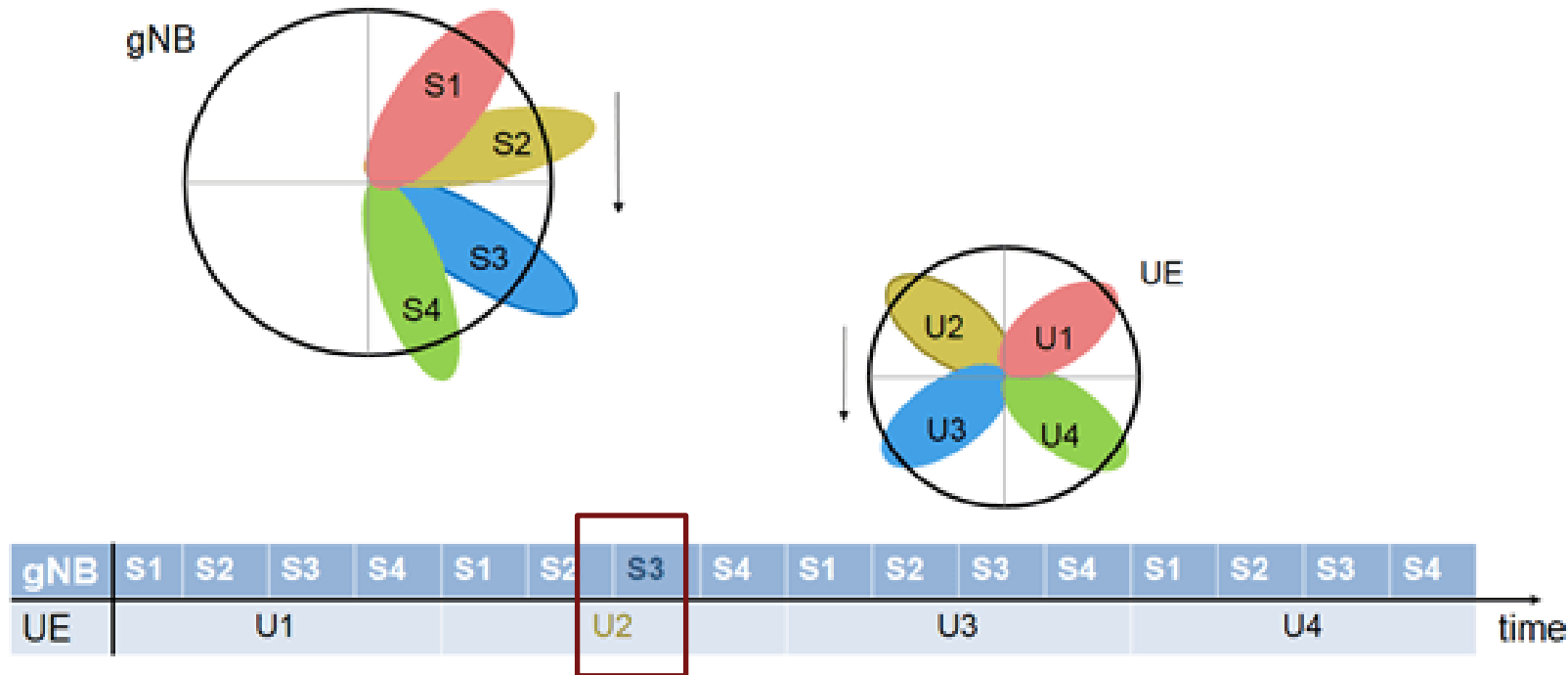

This Tx/Rx beam pair results in the highest reference signal received power (RSRP)

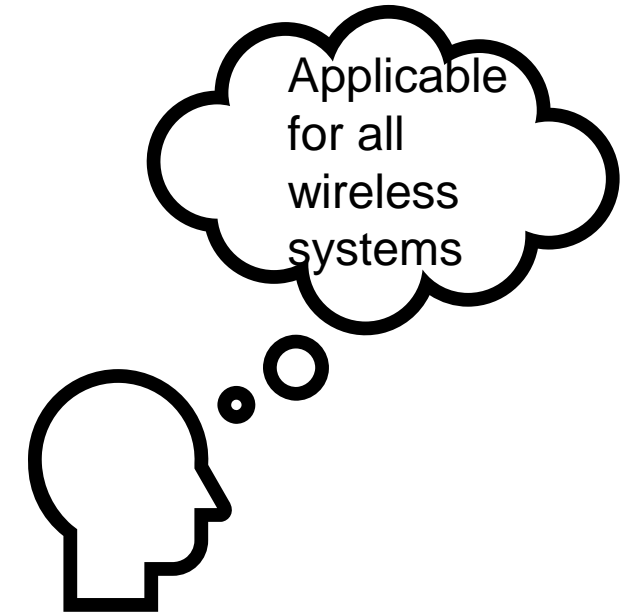

5G NR SSB Beam Sweeping Simulation

- Design fixed Transmitter and scatters, mobile receiver
 - TX Array: 8x8, RX Array: 2x2 - URA
- Add AWGN/ channel effect
- At each location, perform [NR SSB Beam Sweeping](#), and calculate RSRP for each beam
 - Repeat SSB beam sweeping for 4 times to average out the effect of noise
- True optimal beam pair is the one with *highest average RSRP*

Challenge:

When the number of beams goes up, beam sweeping is time-consuming and costly – hence overhead is exponential

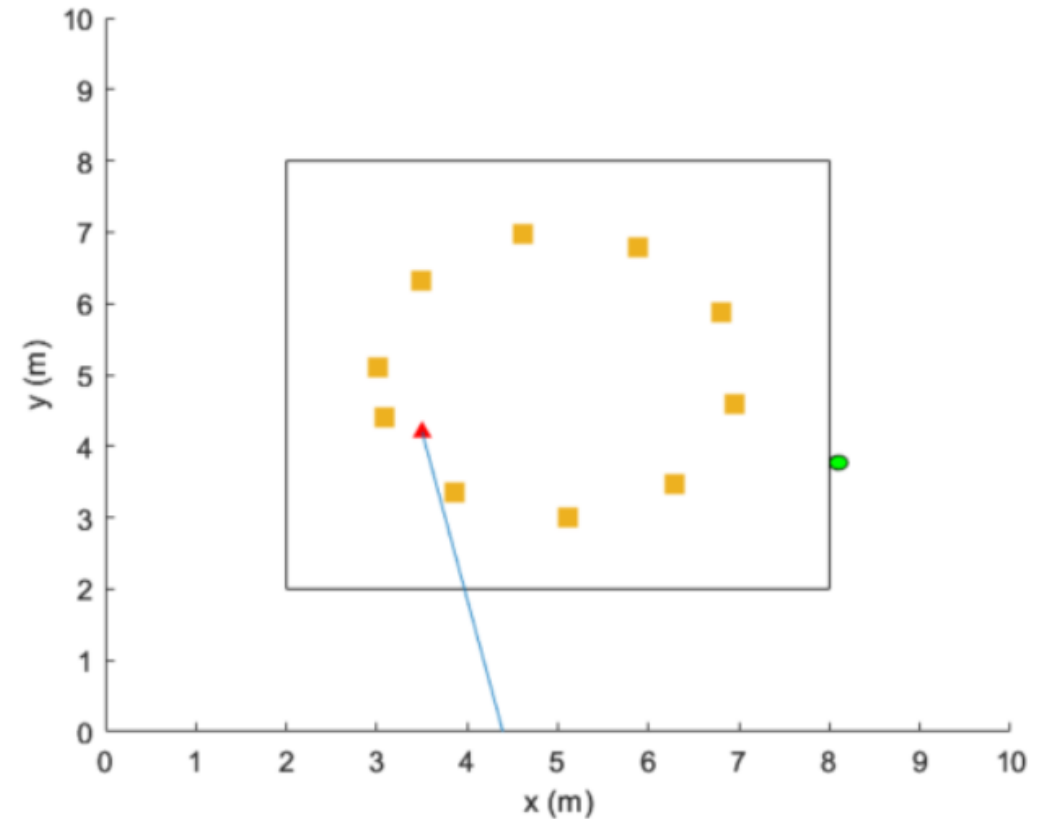

- - UE
- ▲ - gNB
- - Scatterer
- - Selected Beam

Mapping with the workflow we discussed

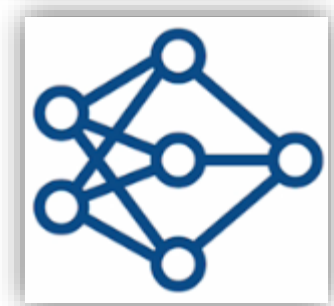
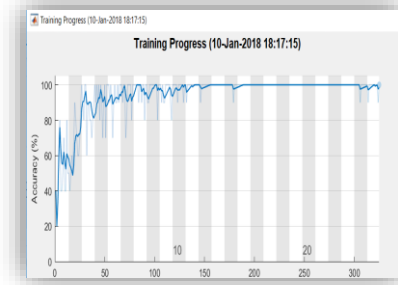
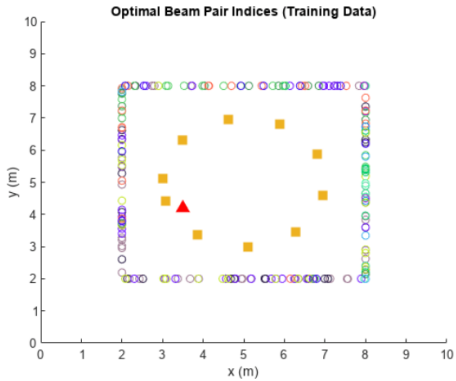

Pre-labeled synthesized

Train AI Model

Trained Model

New Data

Pre-Trained Model

Classification

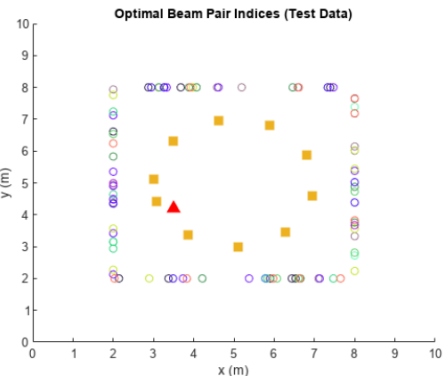

Optimal Beam Pair

Applying the Classical Deep Learning workflow

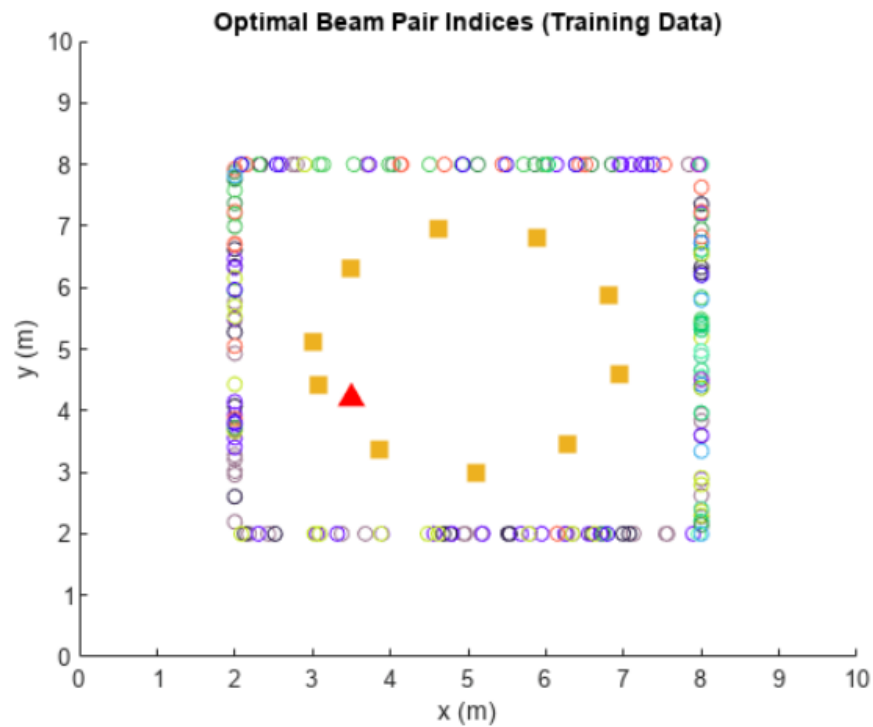
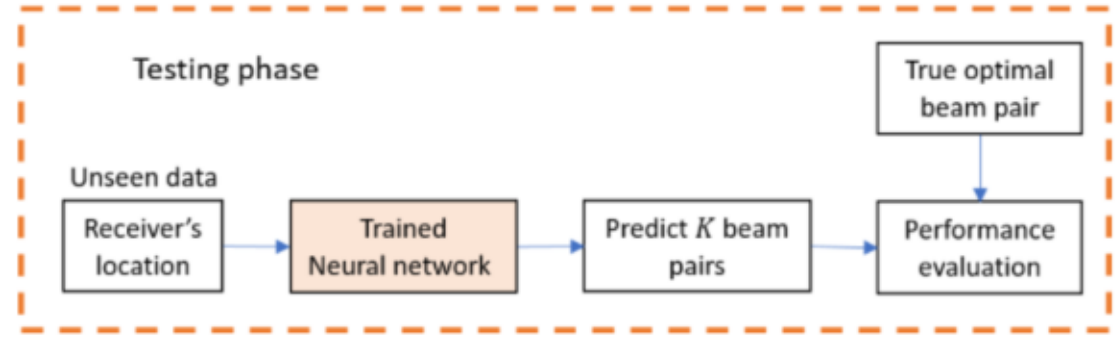
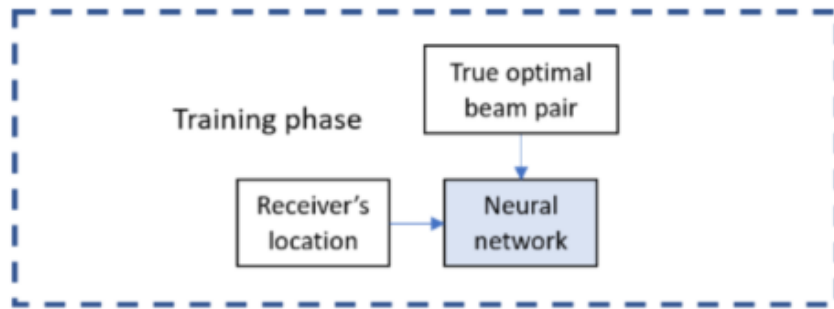

Train

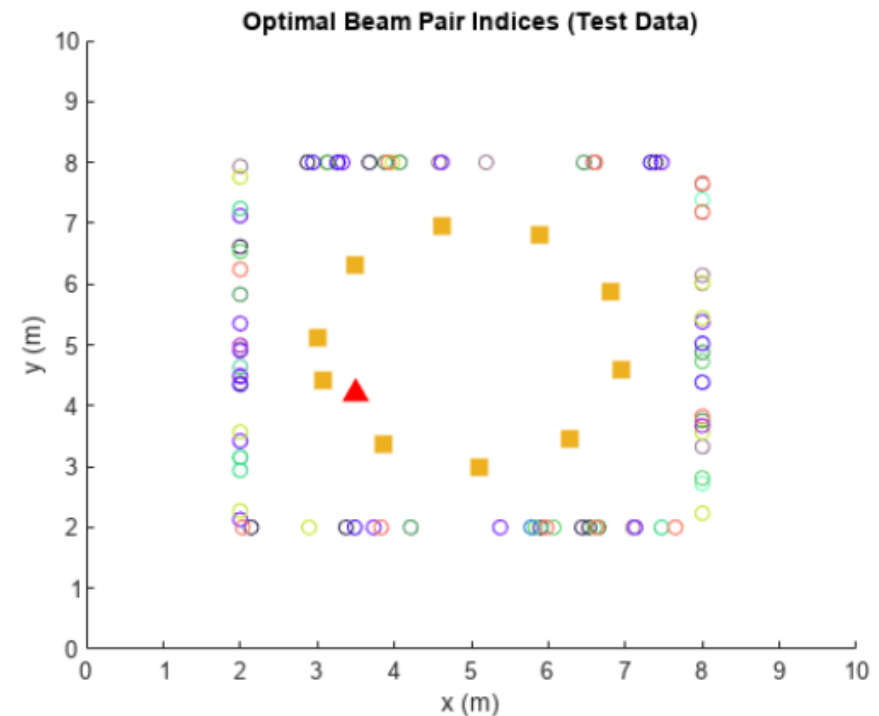

Test

Why MATLAB for AI + Wireless?

Increase productivity using Apps for design and analysis

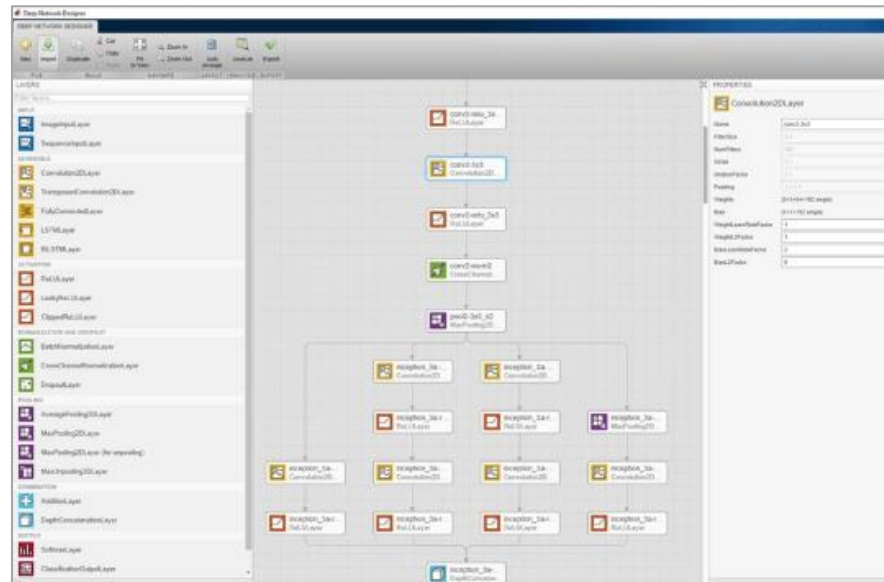

Deep Network Designer app to build, visualize, and edit deep learning networks

The screenshot shows the 'Experiment Manager' application. It displays a table of training experiments. The table has columns for Name, Status, Progress, Stopped Time, Epochs/Epochs, Loss/Validation Loss, Training Time, Training Loss, and Validation Loss. The table shows several experiments, some completed and some running.

Name	Status	Progress	Stopped Time	Epochs/Epochs	Loss/Validation Loss	Training Time	Training Loss	Validation Loss
1	Complete	100%	0:00:00.0000000	1/100000	0.0000000/0.0000000	0:00:00.0000000	0.0000000	0.0000000
2	Complete	100%	0:00:00.0000000	1/100000	0.0000000/0.0000000	0:00:00.0000000	0.0000000	0.0000000
3	Complete	100%	0:00:00.0000000	1/100000	0.0000000/0.0000000	0:00:00.0000000	0.0000000	0.0000000
4	Complete	100%	0:00:00.0000000	1/100000	0.0000000/0.0000000	0:00:00.0000000	0.0000000	0.0000000
5	Complete	100%	0:00:00.0000000	1/100000	0.0000000/0.0000000	0:00:00.0000000	0.0000000	0.0000000
6	Running	75%	0:00:00.0000000	1/100000	0.0000000/0.0000000	0:00:00.0000000	0.0000000	0.0000000
7	Stopped	0%	0:00:00.0000000	1/100000	0.0000000/0.0000000	0:00:00.0000000	0.0000000	0.0000000
8	Stopped	0%	0:00:00.0000000	1/100000	0.0000000/0.0000000	0:00:00.0000000	0.0000000	0.0000000
9	Stopped	0%	0:00:00.0000000	1/100000	0.0000000/0.0000000	0:00:00.0000000	0.0000000	0.0000000
10	Stopped	0%	0:00:00.0000000	1/100000	0.0000000/0.0000000	0:00:00.0000000	0.0000000	0.0000000
11	Stopped	0%	0:00:00.0000000	1/100000	0.0000000/0.0000000	0:00:00.0000000	0.0000000	0.0000000
12	Stopped	0%	0:00:00.0000000	1/100000	0.0000000/0.0000000	0:00:00.0000000	0.0000000	0.0000000
13	Stopped	0%	0:00:00.0000000	1/100000	0.0000000/0.0000000	0:00:00.0000000	0.0000000	0.0000000
14	Stopped	0%	0:00:00.0000000	1/100000	0.0000000/0.0000000	0:00:00.0000000	0.0000000	0.0000000
15	Stopped	0%	0:00:00.0000000	1/100000	0.0000000/0.0000000	0:00:00.0000000	0.0000000	0.0000000
16	Stopped	0%	0:00:00.0000000	1/100000	0.0000000/0.0000000	0:00:00.0000000	0.0000000	0.0000000

Experiment Manager app to manage multiple deep learning experiments, analyze and compare results and code

Applying the Classical Deep Learning workflow

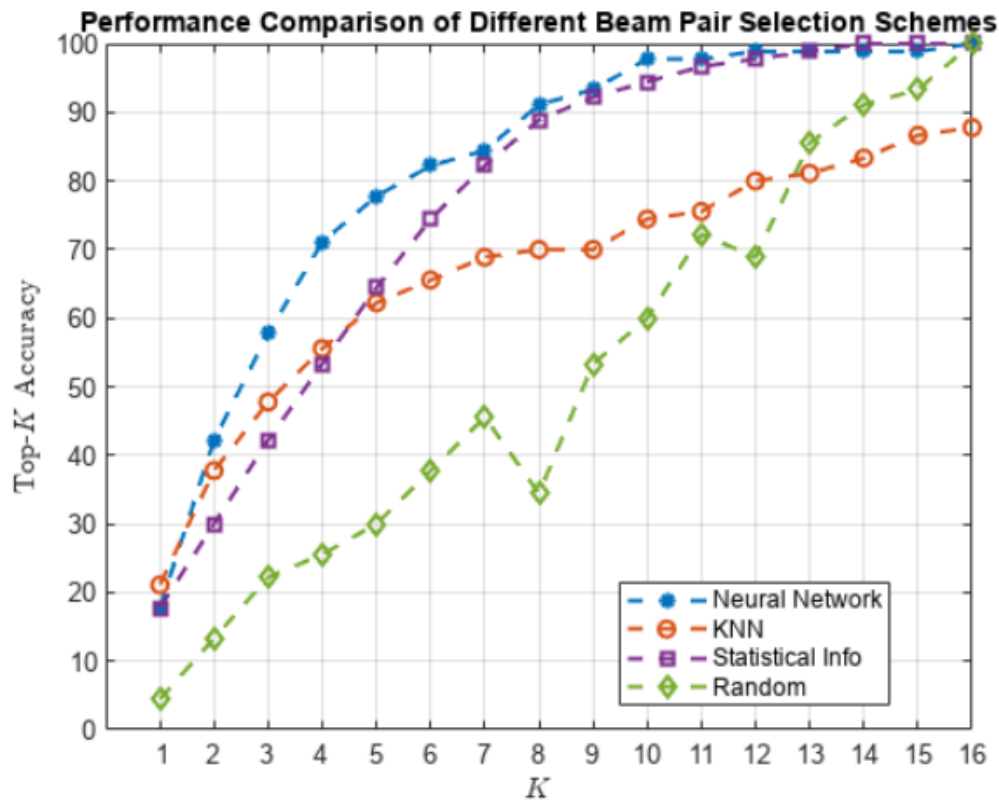

Train a neural network to learn the relationship

Receiver's location	Optimal beam index
(1, 2, 0)	1
(-2, 5, 0)	5
(3, -7, 0)	11
...	...

Testing

Receiver's location	Recommend a set of 3 good beams	True optimal beam index
(-1, -2, 0)	[1, 2, 9]	9 ✓
(-9, -8, 0)	[3, 4, 8]	1 ✗
(2, -1, 0)	[11, 12, 3]	12 ✓
...	...	

Top-K accuracy

Optimal Beam Selection with Reinforcement Learning

Analogies with pet training

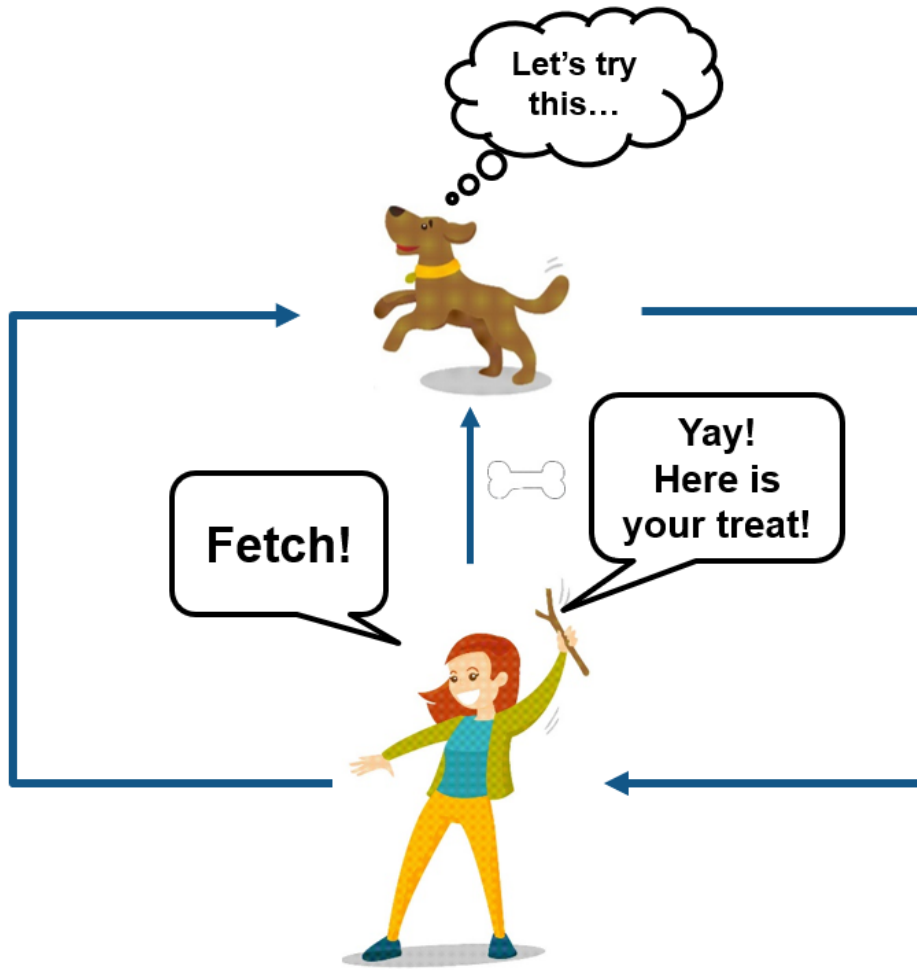

Reinforcement learning works through **trial and error**.

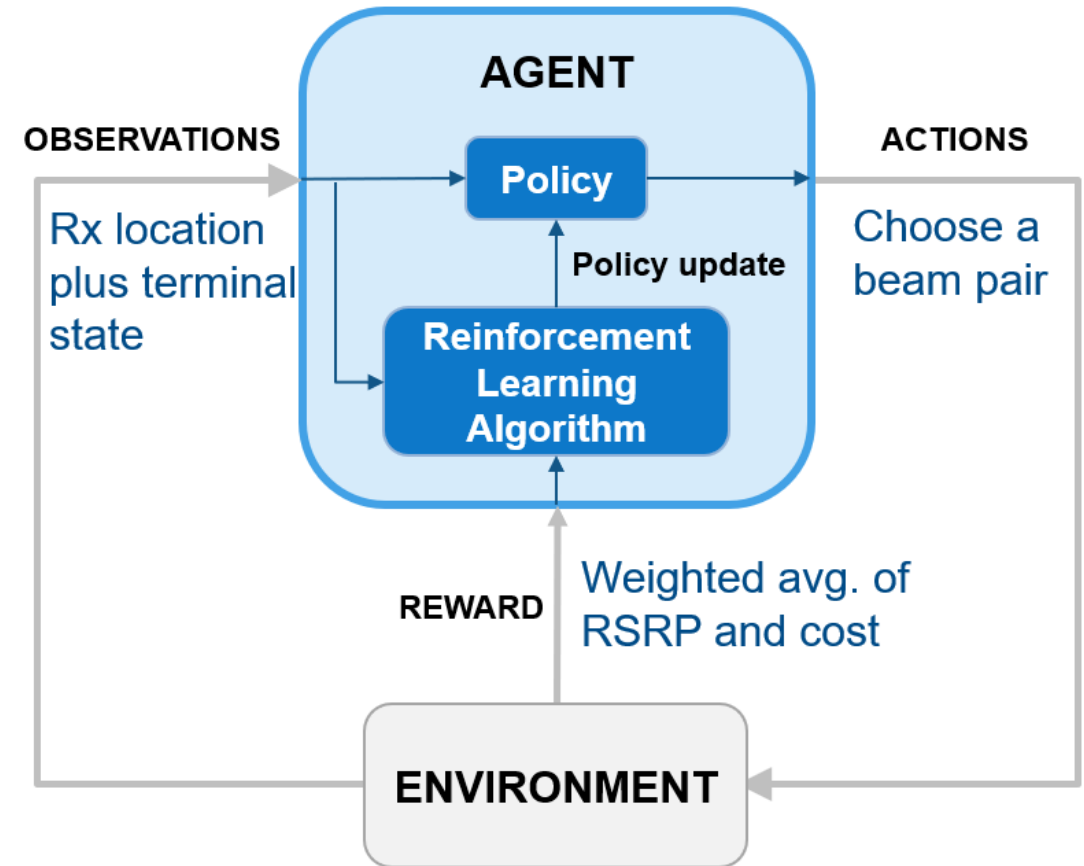

GPS coordinates, channel, system configuration, etc.

Reinforcement Learning in few Steps

- Create Environment specifies the reward function

```
envTrain =
BeamSelectEnv(locationMat, avgRsrpMatTrain, rotAngleMat, position);
```

- Create RL Agent

```
obsInfo = getObservationInfo(envTrain);
actInfo = getActionInfo(envTrain);
agent = rlDQNAgent(obsInfo, actInfo);
```

- Train Agent

```
trainOpts = rlTrainingOptions("MaxEpisodes", 1000, ...
"MaxStepsPerEpisode", 200);
trainingStats = train(agent, envTrain, trainOpts);
```

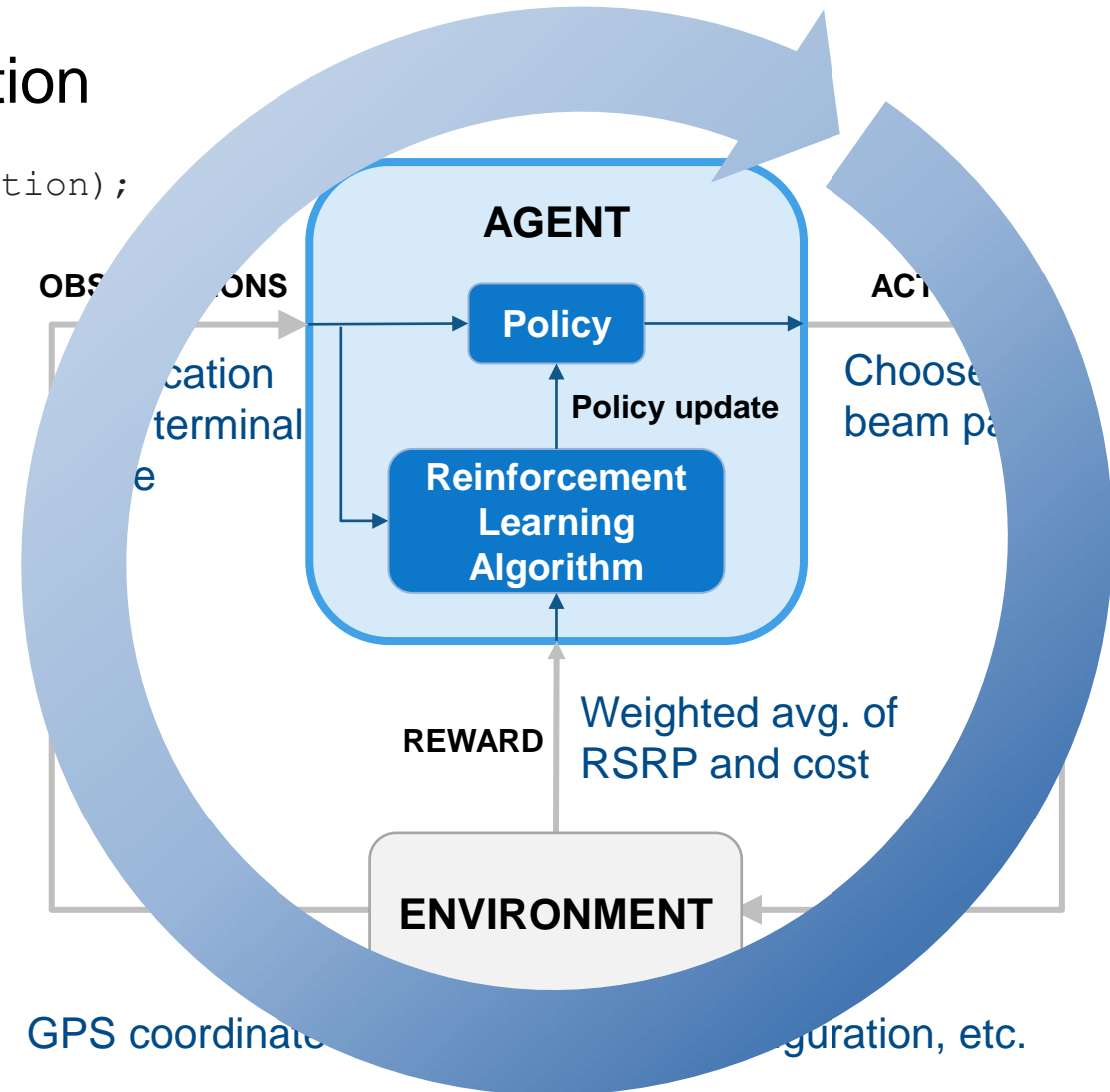

Testing Reinforcement Learning in Test Environment

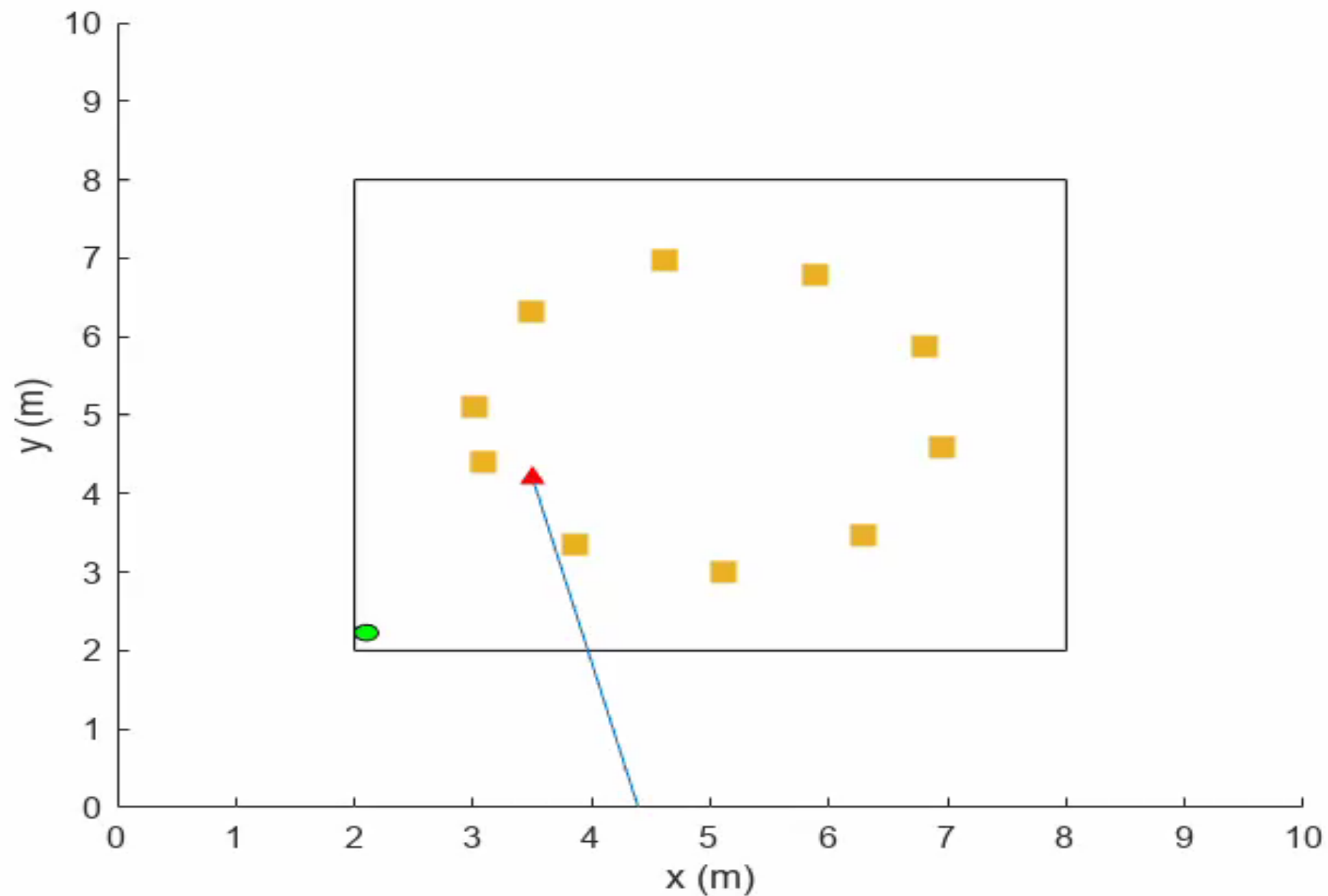

Pros & Cons of Reinforcement Learning

Pros

- **No data** required before training
- **New possibilities** with AI for hard-to-solve problems
- Complex **end-to-end** solutions can be developed
- **Uncertain, nonlinear** environments can be used

Cons

- Trained policies are **hard to verify** (no performance guarantees)
- Many trials/data points required (**sample inefficient**)
 - Training with real hardware can be expensive and dangerous
- Large number of **design parameters**
 - Reward signal
 - Network architectures
 - Training Hyperparameters

Simulations are key in Reinforcement Learning

Simulations and Virtual Models are Key in Reinforcement Learning

Cons of Reinforcement Learning

- Trained policies are **hard to verify** (no performance guarantees)
- Many trials/data points required (**sample inefficient**)
 - Training with real hardware can be expensive and dangerous
- Large number of **design parameters**
 - Reward signal
 - Network architectures
 - Training Hyperparameters

MATLAB® & SIMULINK®

- **Reuse** existing code and models for environments
- Use simulations for **policy verification**
 - Simulate extreme scenarios
- Run simulation trials **in parallel** to accelerate training
- Consult Reinforcement Learning Toolbox **examples**
 - Iterative tuning with simulations

Ways to Deploy,..

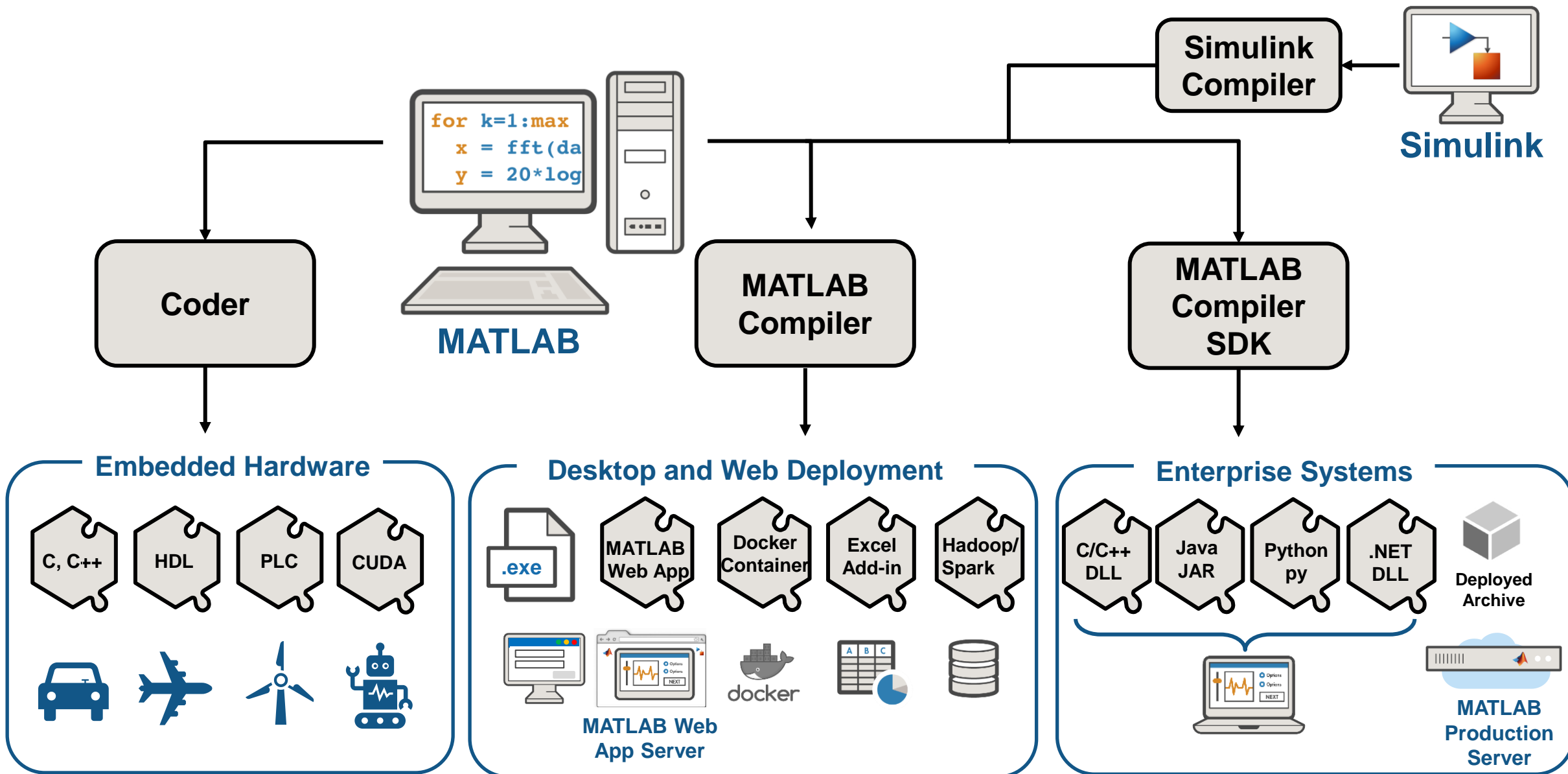

Agenda

- 1 Future of Wireless Ecosystem
- 2 Using AI for wireless
- 3 AI Workflow for Wireless
- 4 Reinforcement learning for 5G
- 5 Summary

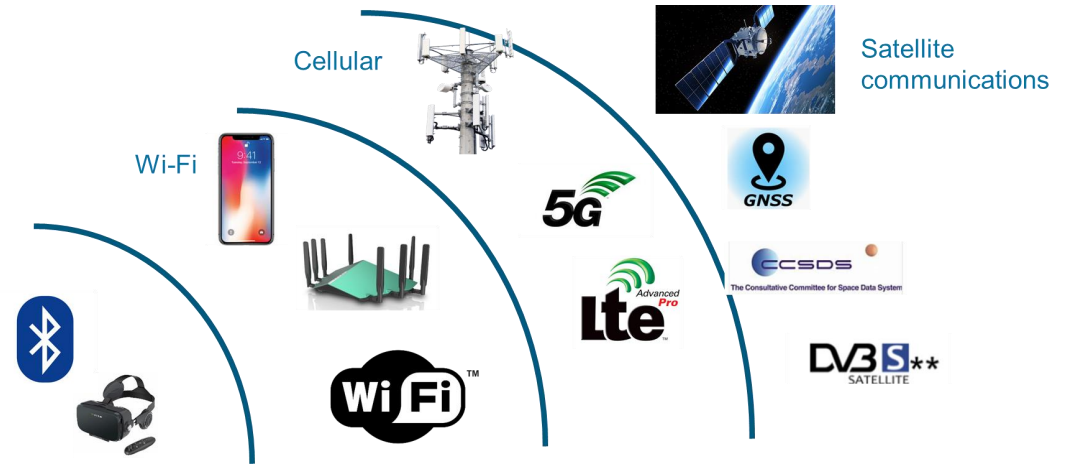

AI-driven system design workflow



Summary:

You can solve advance Wireless problem with AI using MATLAB

Wireless Communications:

- **Synthesize data** (5G, LTE, WLAN, Satellite, Radar, Lidar, GPS, etc)
- Benefit from standard compliant **channel models**
- Build **link-level simulation** (PHY layers + RF front end+ Antenna) and **Network level Simulation**
- From MATLAB to the real world... and back: **Connect to test equipment and SDR**



AI:

- Build and train your AI network in MATLAB by low-code/no-code workflow
- Accelerate the training with no code change
- Collect over-the-air data using SDR and test/retrain your network with real-world data
- Deploy AI network to hardware/ embedded system

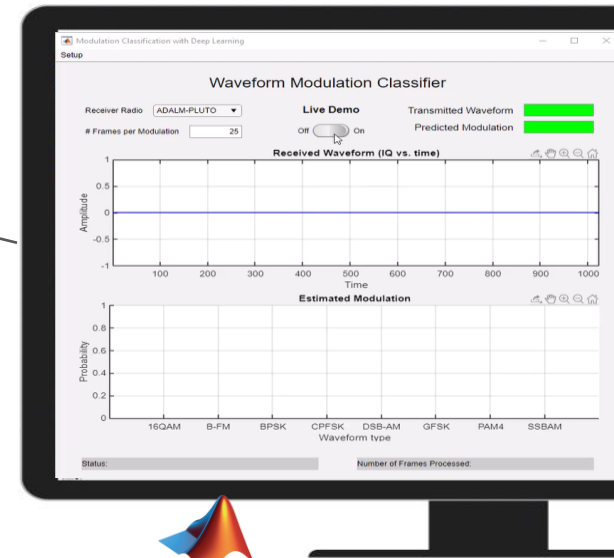

Wireless Communications Development with AI

with MATLAB and Simulink

Related Products

5G Toolbox
 LTE Toolbox
 WLAN Toolbox
 Bluetooth Toolbox
 Satellite Communications Toolbox
 UWB Addon

Related Products

Instrument Control Toolbox
 Wireless Testbench Toolbox
 Software-Defined Radio Add-ons
 MATLAB Compiler
 HDL Coder
 Wireless HDL Toolbox
 SoC Blockset

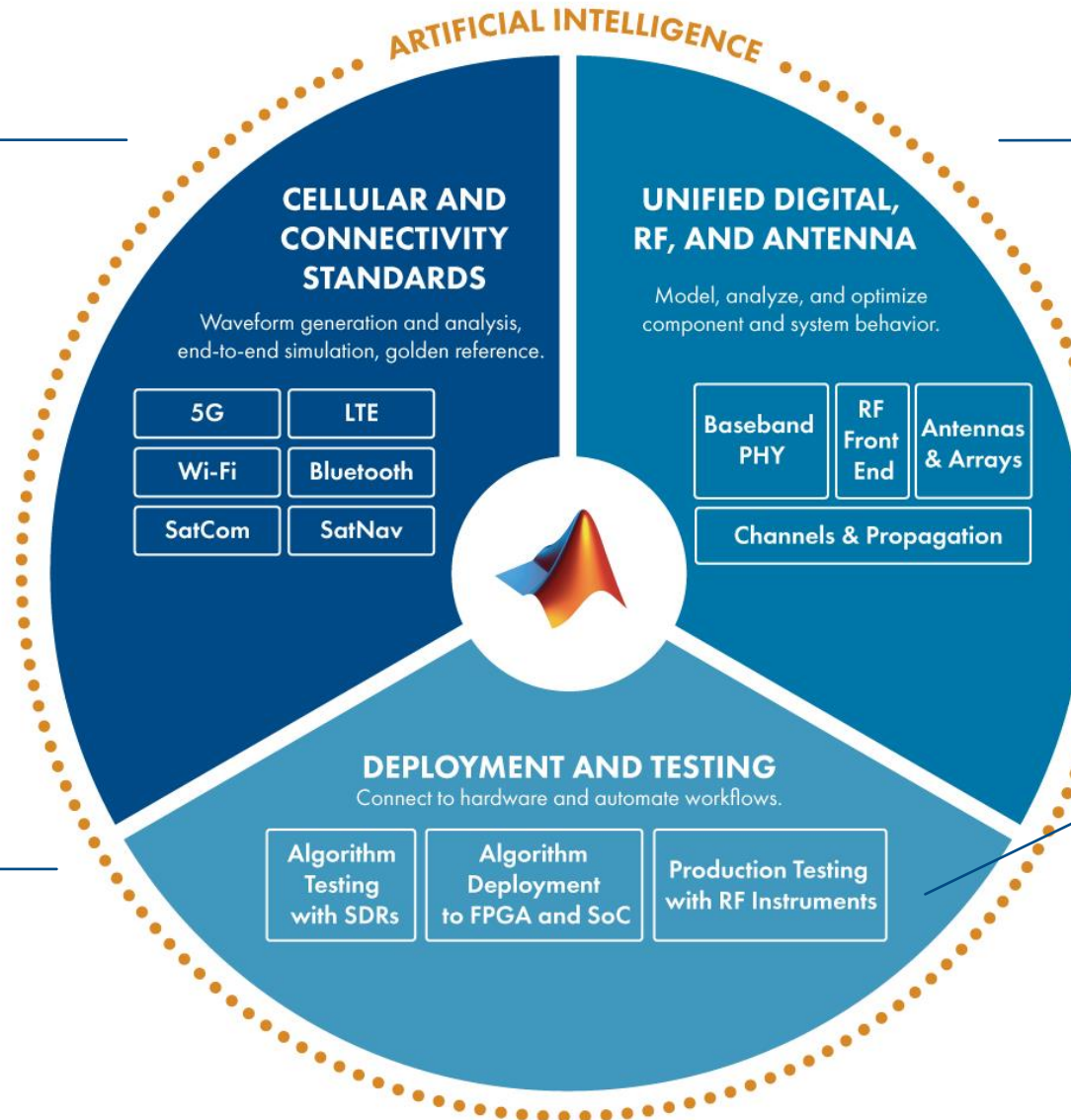

Related Products

Communications Toolbox
 RF Toolbox
 RF Blockset
 Antenna Toolbox
 Phased Array System Toolbox

AI Products

- Statistics and Machine Learning Toolbox
- Deep Learning Toolbox
- Reinforcement Learning Toolbox

Partners



Learn more: mathworks.com/wireless

NanoSemi Improves System Efficiency for 5G

Challenge

Accelerate the design and verification of RF power amplifier linearization algorithms used in 5G and Wi-Fi 6 devices

Solution

Use MATLAB to characterize amplifier performance, develop predistortion and **machine learning algorithms**, and automate standard-compliant test procedures

Results

- Development time reduced by 50%
- Iterative verification process accelerated
- Early customer validation enabled

[Link to user story](#)



NanoSemi linearization IP development and verification using MATLAB.

“At a small company like ours, it’s critical for engineers to work with as little overhead as possible. With MATLAB, our team can deliver leading-edge IP faster, enabling our customers to increase bandwidth, push modulation rates higher, and reduce power consumption.”

- Nick Karter, NanoSemi

MATLAB EXPO

Thank you



© 2022 The MathWorks, Inc. MATLAB and Simulink are registered trademarks of The MathWorks, Inc. See [mathworks.com/trademarks](https://www.mathworks.com/trademarks) for a list of additional trademarks. Other product or brand names may be trademarks or registered trademarks of their respective holders.



MathWorks ✓

@MathWorks

Share the EXPO experience

#MATLABEXPO

MATLAB
EXPO

WELCOME

